



Hardi

Surgical & Dental Instruments



Web: www.hardi.shop

E-mail: contact@hardi.shop

Name	Page
• A reola Markers	2
• Auricular Plastic Instruments	3
• Breast Dissectors and Elevator	4-7
• Breast Retractors	8-19
• Cartilage And Bone Instruments	20-22
• Chisels and Gouges	23-26
• Dermatomes	27
• Dissectors and Elevators	28-35
• Lip and Cheek Retractors	36
• Lip and Cleft Palate Instruments	37-38
• Mallets	39
• Marking And Measuring Instruments	40-43
• Maxilla Mobilizer	43
• Mouth Gags	44
• Mucosa Knife And Raspatories	45
• Rhinoplasty Instruments	46-68
• Septum Straightening Forceps	69-70
• Osteotomes and Raspatories	71-85
• Suction Raspatories	86
• Wires And Wire Instruments	87
• Suggested Instruments	88
• Delicate Dressing & Tissue Forceps	89-92
• Hemostatic Forceps	93-96
• Micro Forceps	97-99
• Tissue Grasping Forceps	100-101
• Needle Holders	102-109
• Micro Needle Holders	110-111
• Retractors	112-123
• Delicate Retractors	124-131
• Self Retaining Retractors	132-134
• Scalpel Handles	135-136
• Delicate Scissors	137-139
• Delicate Dissecting Scissors	140-146
• Dissecting Scissors	147-158
• Gum Scissors	159
• Ligature and Stitch Scissors	160-161
• Micro Scissors	162-163



Item Code	Description
01-AR-02	GROSSMANN AREOLA MARKER, 40MM,44MM 48MM, 52MM



Item Code	Description
01-AR-06	FREEMAN AREOLA MARKER, 2 SIZES, 34MM / 36MM
01-AR-07	FREEMAN AREOLA MARKER, 2 SIZES, 38MM / 42MM
01-AR-08	FREEMAN AREOLA MARKER, 2 SIZES, 42MM / 45MM
01-AR-09	FREEMAN AREOLA MARKER, 2 SIZES, 45MM / 50MM



Item Code	Description
01-AR-22	FREEMAN AREOLA MARKER, 34MM
01-AR-23	FREEMAN AREOLA MARKER, 36MM
01-AR-24	FREEMAN AREOLA MARKER, 38MM
01-AR-25	FREEMAN AREOLA MARKER, 42MM
01-AR-26	FREEMAN AREOLA MARKER, 45MM
01-AR-27	FREEMAN AREOLA MARKER, 50MM



STAINLESS STEEL

Item Code	Description
01-AR-31	FREEMAN AREOLA MARKER, 38 MM
01-AR-32	FREEMAN AREOLA MARKER, 42 MM
01-AR-33	FREEMAN AREOLA MARKER, 50 MM
01-AR-34	FREEMAN AREOLA MARKER, 45 MM
01-AR-35	FREEMAN AREOLA MARKER, 34 MM
01-AR-36	FREEMAN AREOLA MARKER, 36 MM



Item Code	Description
01-AR-41	SOLZ AREOLA MARKER, BLUNT, 36MM DIAMETER
01-AR-42	SOLZ AREOLA MARKER, BLUNT, 40MM DIAMETER
01-AR-43	SOLZ AREOLA MARKER, BLUNT, 42MM DIAMETER
01-AR-44	SOLZ AREOLA MARKER, BLUNT, 45MM DIAMETER



Item Code	Description
02-API-01	UNIVERSAL T. C. WIRE CUTTING SCISSORS, 12CM

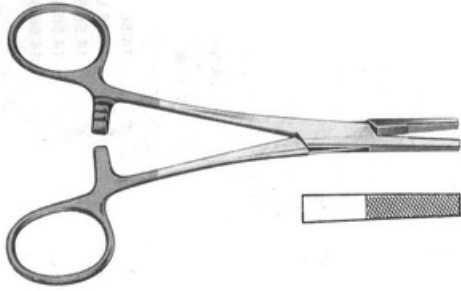

Item Code	Description
02-API-02	NIRO T.C. WIRE TWISTING FORCEPS, 15CM

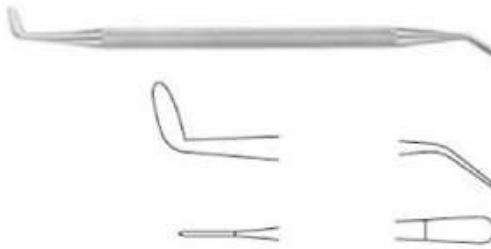

Item Code	Description
02-API-03	NAGATA AURICULAR SEPTUM ELEVATOR, 16CM, BLUNT
02-API-04	NAGATA AURICULAR SEPTUM ELEVATOR, 17CM, BLUNT



Item Code	Description
02-API-05	DOYEN RIB RASPATORY, 17CM, RIGHT
02-API-06	DOYEN RIB RASPATORY, 17CM, LEFT

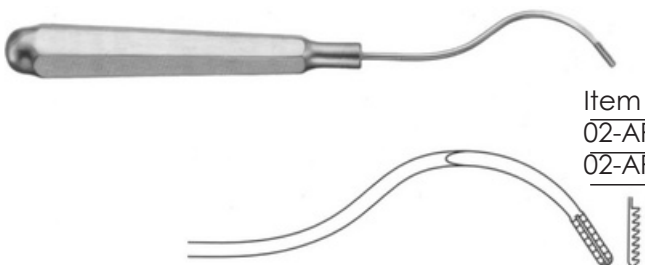

Item Code	Description
02-API-07	KISTLER ANTHELIX CARTILAGE RASP, RIGHT
02-API-08	KISTLER ANTHELIX CARTILAGE FILE, LEFT



Item Code	Description
03-BD-01	SOLZ ATRAUMATIC BREAST DISSECTOR, 34CM
03-BD-02	SOLZ ATRAUMATIC BREAST DISSECTOR, 37CM



Item Code	Description
03-BD-03	SOLZ BREAST HOOK DISSECTOR, 36CM



Item Code	Description
03-BD-04	AGRIS DINGMAN BREAST DISSECTOR, SET OF 2, LEFT AND RIGHT, 36CM



Item Code	Description
03-BD-07	MACCOLLUM DINGMAN SUBMAMMARY DISSECTOR, 30 CM



Item Code	Description
03-BD-08	MACCOLLUM DINGMAN BREAST DISSECTOR, 31.5 CM
03-BD-09	MACCOLLUM DINGMAN BREAST DISSECTOR, 41 CM



Item Code	Description
03-BD-10	REYNOLDS TRANSAUXILLARY BREAST DISSECTOR, FENESTRATED, 33CM
03-BD-11	REYNOLDS TRANSAUXILLARY BREAST DISSECTOR, FENESTRATED, 40CM



Item Code	Description
03-BD-12	BREAST DISSECTOR, ANGULATED BLADE, 33CM
03-BD-13	BREAST DISSECTOR, ANGULATED BLADE, 42CM



Item Code	Description
03-BD-14	BREAST DISSECTOR, SPATULATED BLADE, 33CM
03-BD-15	BREAST DISSECTOR, SPATULATED BLADE, 42CM



Item Code	Description
03-BD-16	BREAST DISSECTOR, OVAL SPATULATED BLADE, 33CM
03-BD-17	BREAST DISSECTOR, OVAL SPATULATED BLADE, 42CM



Item Code	Description
03-BD-20	TROCAR BREAST TUBE, 14" (356 MM) TOTAL LENGTH, LARGE, 17.3 MM ID, 19.0 MM OD
03-BD-21	TROCAR BREAST TUBE, 13 1/2" (343), SMALL, 14 MM ID, 16 MM OD



Item Code	Description
03-BD-29	PENN BREAST DISSECTOR, STRAIGHT, 1" (25 MM) WIDTH, 12 3/4" (324 MM) LENGTH



Item Code	Description
03-BD-30	MACCOLLUM DINGMAN BREAST DISSECTOR, 1 1/2" (38 MM) WIDTH, 17 1/2" (432 MM) LENGTH



Item Code	Description
03-BD-32	MCINNIS POLYCURETTE BREAST INSTRUMENT, 1 1/64" (30 MM) WIDTH, 12 1/2" (318 MM) LENGTH

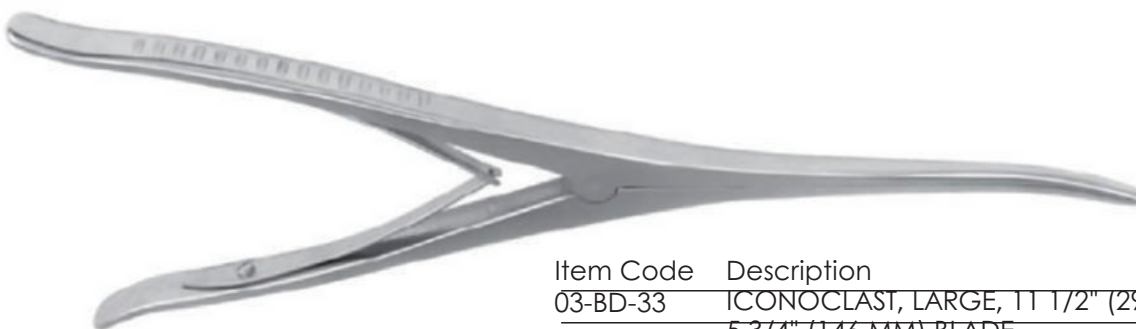

Item Code	Description
03-BD-33	ICONOCLAST, LARGE, 11 1/2" (292 MM) LENGTH, 5 3/4" (146 MM) BLADE
03-BD-34	ICONOCLAST, SMALL, 8 3/4" (222 MM) LENGTH, 3 1/4" (83 MM) BLADE



Item Code	Description
03-BD-35	SILVERSTEIN BREAST DISSECTOR, 14" (356 MM) LENGTH



Item Code	Description
03-BD-36	SPATULA BREAST RETRACTOR / DISSECTOR, SERRATED, 12 1/2", SEMI MALLEABLE



Item Code	Description
04-BE-01	BREAST ELEVATOR FOR MAMMARY PLASTY



Item Code	Description
05-BR-01	MARX BREAST RETRACTOR, 27CM, 125 X 30MM
05-BR-02	MARX BREAST RETRACTOR, 27CM, 140 X 30MM



FERRIERA STYLE RETRACTOR, WITH FIBER OPTIC LIGHT GUIDE

With Smoke Tube		Without Smoke Tube	
Item Code	Description	Item Code	Description
05-BR-03-0170	X 16 mm	05-BR-03-1670	X 16 mm
05-BR-03-0280	X 16 mm	05-BR-03-1780	X 16 mm
05-BR-03-0390	X 27 mm	05-BR-03-1890	X 27 mm
05-BR-03-04110	X 25 mm	05-BR-03-19110	X 25 mm
05-BR-03-05120	X 25 mm	05-BR-03-20120	X 25 mm
05-BR-03-06130	X 16 mm	05-BR-03-21130	X 16 mm
05-BR-03-07130	X 25 mm	05-BR-03-22130	X 25 mm
05-BR-03-08150	X 25 mm	05-BR-03-23150	X 25 mm
05-BR-03-09150	X 30 mm	05-BR-03-24150	X 30 mm
05-BR-03-10150	X 36 mm	05-BR-03-25150	X 36 mm
05-BR-03-11180	X 16 mm	05-BR-03-26180	X 16 mm
05-BR-03-12180	X 25 mm	05-BR-03-27180	X 25 mm
05-BR-03-13190	X 25 mm	05-BR-03-28190	X 25 mm
05-BR-03-14190	X 36 mm	05-BR-03-29190	X 36 mm
05-BR-03-15220	X 27 mm	05-BR-03-30220	X 27 mm



Item Code	Description
05-BR-19	BIGGS MAMMAPLASTY RETRACTORS, 30MM, WITH FIBER OPTIC LIGHT GUIDE
05-BR-20	BIGGS MAMMAPLASTY RETRACTORS, 50MM, WITH FIBER OPTIC LIGHT GUIDE
05-BR-21	BIGGS MAMMAPLASTY RETRACTORS, 30MM, WITH FIBER OPTIC LIGHT GUIDE AND SUCTION
05-BR-22	BIGGS MAMMAPLASTY RETRACTORS, 50MM, WITH FIBER OPTIC LIGHT GUIDE AND SUCTION



Item Code	Description
05-BR-25	WIEDER BREAST AND FACIAL RETRACTOR / TONGUE DEPRESSOR, SERRATED, (14 CM), 28MM, WITH FIBER OPTIC LIGHT GUIDE
05-BR-26	WIEDER BREAST AND FACIAL RETRACTOR / TONGUE DEPRESSOR, SERRATED, (14 CM), 38MM, WITH FIBER OPTIC LIGHT GUIDE
05-BR-27	WIEDER BREAST AND FACIAL RETRACTOR / TONGUE DEPRESSOR, SERRATED, (15 CM), 45MM, WITH FIBER OPTIC LIGHT GUIDE



Item Code	Description
05-BR-28	BREAST SPATULA WITH HANDLE 31.5 CM, 25MM X 18 CM BLADE, SERRATED TIP, SEMI MALLABLE



Item Code	Description
05-BR-29	BREAST RETRACTOR, DOUBLE ENDED, (31 CM), BLADES 22MM X 55MM AND 38MM X 70MM
05-BR-31	BREAST RETRACTOR, DOUBLE ENDED, (24 CM), BLADES 22MM X 55MM AND 38MM X 70MM



Item Code	Description
05-BR-32	WIEDER BREAST AND FACIAL RETRACTOR / TONGUE DEPRESSOR, SERRATED, (14 CM), 28MM
05-BR-33	WIEDER BREAST AND FACIAL RETRACTOR / TONGUE DEPRESSOR, SERRATED, (14 CM), 38MM
05-BR-34	WIEDER BREAST AND FACIAL RETRACTOR / TONGUE DEPRESSOR, SERRATED, (15 CM), 45MM



Item Code	Description
05-BR-35	BIGGS MAMMAPLASTY RETRACTOR, 50 MM WIDTH, STANDARD, 20 CM LENGTH



Item Code	Description
05-BR-36	BIGGS MAMMAPLASTY RETRACTOR, WITH FIBER OPTIC LIGHT GUIDE 5.0 CM BLADE WIDTH, 20 CM LENGTH



Item Code	Description
05-BR-37	BIGGS MAMMAPLASTY RETRACTOR, 3 CM BLADE WIDTH, NARROW, (171 MM) LENGTH



Item Code	Description
05-BR-38	BIGGS MAMMAPLASTY RETRACTOR, WITH FIBER OPTIC LIGHT GUIDE, NARROW, 3.0 CM BLADE WIDTH, 15 CM LENGTH

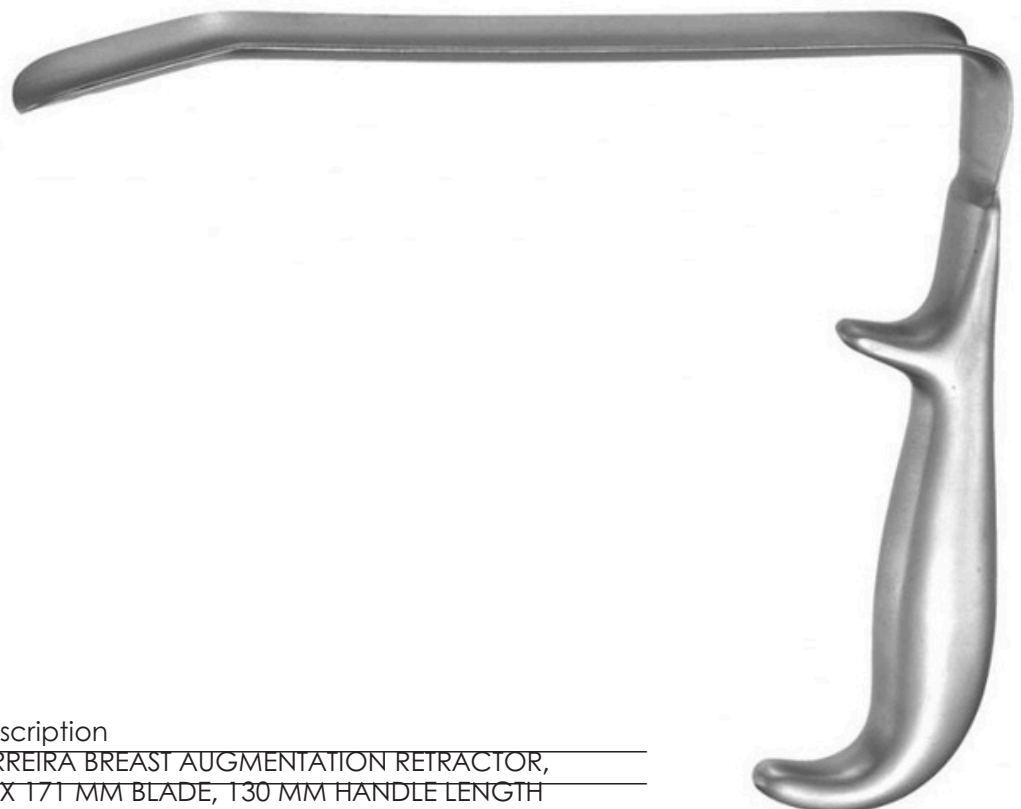

Item Code	Description
05-BR-39	FERREIRA BREAST AUGMENTATION RETRACTOR, 25 X 171 MM BLADE, 130 MM HANDLE LENGTH



Item Code	Description
05-BR-40	FERREIRA BREAST AUGMENTATION
	RETRACTOR, WITH FIBER OPTIC LIGHT
	GUIDE, 25 X 171 MM BLADE WIDTH,
	130 MM HANDLE LENGTH WIDTH



TEBBETTS RETRACTOR WITH FIBER OPTIC LIGHT GUIDE, 18.5CM

With IRRIGATION TUBE

Item Code	Description
05-BR-41-0170	X 16 mm
05-BR-41-0280	X 16 mm
05-BR-41-0390	X 27 mm
05-BR-41-04110	X 25 mm
05-BR-41-05120	X 25 mm
05-BR-41-06130	X 16 mm
05-BR-41-07130	X 25 mm
05-BR-41-08150	X 25 mm
05-BR-41-09150	X 30 mm
05-BR-41-10150	X 36 mm
05-BR-41-11180	X 16 mm
05-BR-41-12180	X 25 mm
05-BR-41-13190	X 25 mm
05-BR-41-14190	X 36 mm
05-BR-41-15220	X 27 mm

Without IRRIGATION TUBE

Item Code	Description
05-BR-41-1670	X 16 mm
05-BR-41-1780	X 16 mm
05-BR-41-1890	X 27 mm
05-BR-41-19110	X 25 mm
05-BR-41-20120	X 25 mm
05-BR-41-21130	X 16 mm
05-BR-41-22130	X 25 mm
05-BR-41-23150	X 25 mm
05-BR-41-24150	X 30 mm
05-BR-41-25150	X 36 mm
05-BR-41-26180	X 16 mm
05-BR-41-27180	X 25 mm
05-BR-41-28190	X 25 mm
05-BR-41-29190	X 36 mm
05-BR-41-30220	X 27 mm



Tebbetts Fiber Optic retractor,
With Double Handle and Teeth at Tip

With Smoke Tube	
Item Code	Description
R-09-53-01	70 X 16 mm
R-09-53-02	80 X 16 mm
R-09-53-03	90 X 27 mm
R-09-53-04	110 X 25 mm
R-09-53-05	120 X 25 mm
R-09-53-06	130 X 16 mm
R-09-53-07	130 X 25 mm
R-09-53-08	150 X 25 mm
R-09-53-09	150 X 30 mm
R-09-53-10	150 X 36 mm
R-09-53-11	180 X 16 mm
R-09-53-12	180 X 25 mm
R-09-53-13	190 X 25 mm
R-09-53-14	190 X 36 mm
R-09-53-15	220 X 27 mm

Without Smoke Tube	
Item Code	Description
R-09-53-16	70 X 16 mm
R-09-53-17	80 X 16 mm
R-09-53-18	90 X 27 mm
R-09-53-19	110 X 25 mm
R-09-53-20	120 X 25 mm
R-09-53-21	130 X 16 mm
R-09-53-22	130 X 25 mm
R-09-53-23	150 X 25 mm
R-09-53-24	150 X 30 mm
R-09-53-25	150 X 36 mm
R-09-53-26	180 X 16 mm
R-09-53-27	180 X 25 mm
R-09-53-28	190 X 25 mm
R-09-53-29	190 X 36 mm
R-09-53-30	220 X 27 mm





Tebbetts Fiber Optic retractor, Insulated Blade With Teeth 18.5cm

With Smoke Tube		Without ISmoke Tube	
Item Code	Description	Item Code	Description
R-09-54-01	70 X 16 mm	R-09-54-16	70 X 16 mm
R-09-54-02	80 X 16 mm	R-09-54-17	80 X 16 mm
R-09-54-03	90 X 27 mm	R-09-54-18	90 X 27 mm
R-09-54-04	110 X 25 mm	R-09-54-19	110 X 25 mm
R-09-54-05	120 X 25 mm	R-09-54-20	120 X 25 mm
R-09-54-06	130 X 16 mm	R-09-54-21	130 X 16 mm
R-09-54-07	130 X 25 mm	R-09-54-22	130 X 25 mm
R-09-54-08	150 X 25 mm	R-09-54-23	150 X 25 mm
R-09-54-09	150 X 30 mm	R-09-54-24	150 X 30 mm
R-09-54-10	150 X 36 mm	R-09-54-25	150 X 36 mm
R-09-54-11	180 X 16 mm	R-09-54-26	180 X 16 mm
R-09-54-12	180 X 25 mm	R-09-54-27	180 X 25 mm
R-09-54-13	190 X 25 mm	R-09-54-28	190 X 25 mm
R-09-54-14	190 X 36 mm	R-09-54-29	190 X 36 mm
R-09-54-15	220 X 27 mm	R-09-54-30	220 X 27 mm

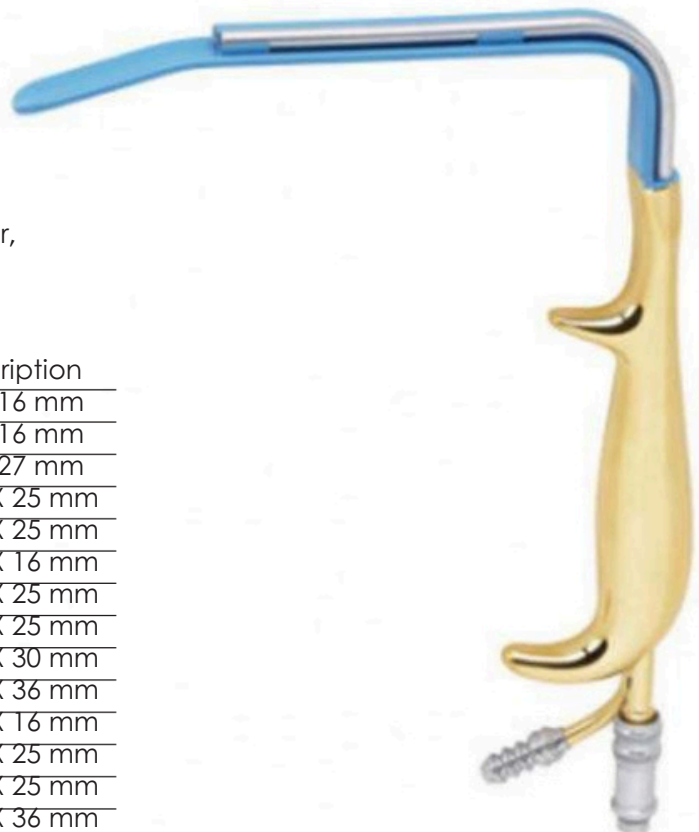

Tebbetts Breast Augmentation Fiber Optic Retractor, Insulated Blade With Smooth End, 18.5 cm

With Smoke Tube		Without Smoke Tube	
Item Code	Description	Item Code	Description
R-09-56-01	70 X 16 mm	R-09-56-16	70 X 16 mm
R-09-56-02	80 X 16 mm	R-09-56-17	80 X 16 mm
R-09-56-03	90 X 27 mm	R-09-56-18	90 X 27 mm
R-09-56-04	110 X 25 mm	R-09-56-19	110 X 25 mm
R-09-56-05	120 X 25 mm	R-09-56-20	120 X 25 mm
R-09-56-06	130 X 16 mm	R-09-56-21	130 X 16 mm
R-09-56-07	130 X 25 mm	R-09-56-22	130 X 25 mm
R-09-56-08	150 X 25 mm	R-09-56-23	150 X 25 mm
R-09-56-09	150 X 30 mm	R-09-56-24	150 X 30 mm
R-09-56-10	150 X 36 mm	R-09-56-25	150 X 36 mm
R-09-56-11	180 X 16 mm	R-09-56-26	180 X 16 mm
R-09-56-12	180 X 25 mm	R-09-56-27	180 X 25 mm
R-09-56-13	190 X 25 mm	R-09-56-28	190 X 25 mm
R-09-56-14	190 X 36 mm	R-09-56-29	190 X 36 mm
R-09-56-15	220 X 27 mm	R-09-56-30	220 X 27 mm

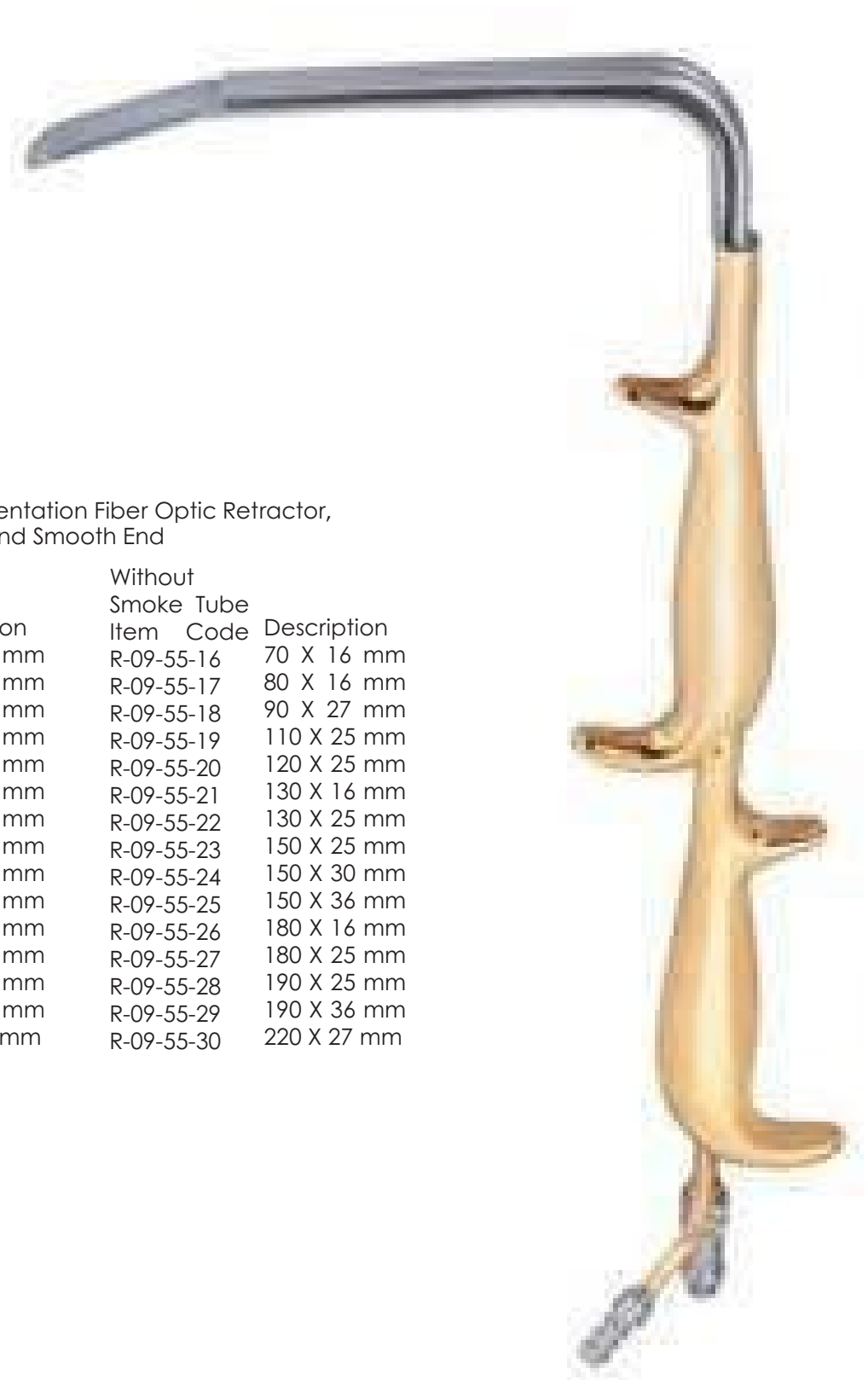

Tebbetts Breast Augmentation Fiber Optic Retractor,
With Double Handle and Smooth End

With Smoke Tube		Without Smoke Tube	
Item Code	Description	Item Code	Description
R-09-55-01	70 X 16 mm	R-09-55-16	70 X 16 mm
R-09-55-02	80 X 16 mm	R-09-55-17	80 X 16 mm
R-09-55-03	90 X 27 mm	R-09-55-18	90 X 27 mm
R-09-55-04	110 X 25 mm	R-09-55-19	110 X 25 mm
R-09-55-05	120 X 25 mm	R-09-55-20	120 X 25 mm
R-09-55-06	130 X 16 mm	R-09-55-21	130 X 16 mm
R-09-55-07	130 X 25 mm	R-09-55-22	130 X 25 mm
R-09-55-08	150 X 25 mm	R-09-55-23	150 X 25 mm
R-09-55-09	150 X 30 mm	R-09-55-24	150 X 30 mm
R-09-55-10	150 X 36 mm	R-09-55-25	150 X 36 mm
R-09-55-11	180 X 16 mm	R-09-55-26	180 X 16 mm
R-09-55-12	180 X 25 mm	R-09-55-27	180 X 25 mm
R-09-55-13	190 X 25 mm	R-09-55-28	190 X 25 mm
R-09-55-14	190 X 36 mm	R-09-55-29	190 X 36 mm
R-09-55-15	220 X 27 mm	R-09-55-30	220 X 27 mm



Item Code	Description
R-09-57-01	Sculpo Breast Retractors, 180 X 25mm Blade Size, With 5mm Endoscopic Scope Sheath
R-09-57-02	Sculpo Breast Retractors, 180 X 25mm Blade Size, With 10mm Endoscopic Scope Sheath



Item Code	Description
R-09-62	Ring breast retractor with fiber optic illumination and irrigation tube



Item Code	Description
06-CBI-01	MAYO SCISSORS, SUPERCUT PLUS T.C. (TUNGSTEN CARBIDE) 17CM, CURVED



Item Code	Description
06-CBI-03	COTTLE CARTILAGE CRUSHER, WITH CLAMP, FOR TAKING OUT THE PREPARED MATERIAL, 65X30X30MM



Item Code	Description
06-CBI-04	CARTILAGE CUTTING BLOCK, TEFLON, 85X55X10MM



Item Code	Description
06-CBI-05	GUBISCH CARTILAGE CRUSHER, 65X30MM

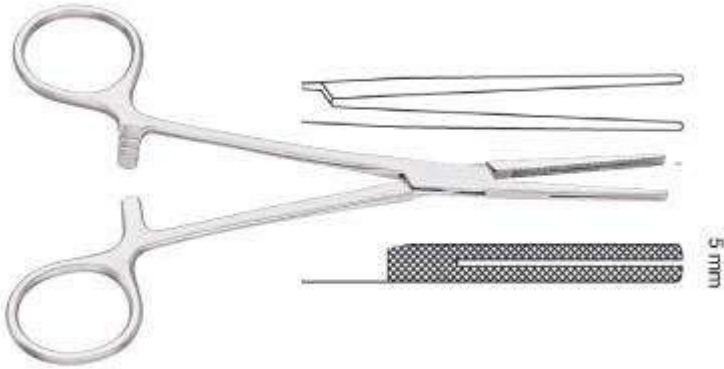

Item Code	Description
06-CBI-06	AIACH FORCEPS, 16CM, 5MM TIP



Item Code	Description
06-CBI-07	DINGMAN CARTILAGE ABRADERS, SET OF TWO



Item Code	Description
06-CBI-12	RUBIN SEPTAL MORSELIZER FORCEPS, 21CM



Item Code	Description
06-CBI-14	RUBIN SEPTAL MORSELIZER FORCEPS, T.C. (TUNGSTEN CARBIDE) 20CM



Item Code	Description
06-CBI-15	BONE MILL, WITH ASSEMBLING WRENCH



Item Code	Description
07-CG-01	FREER SEPTUM CHISEL, 15.5CM, 4MM
07-CG-02	FREER SEPTUM CHISEL, 15.5CM, 6MM



Item Code	Description
07-CG-03	BALLENGER SEPTUM CHISEL, 16CM, 4MM
07-CG-04	BALLENGER SEPTUM CHISEL, 16CM, 6MM



Item Code	Description
07-CG-05	KILLIAN NASAL GOUGE, 17.5CM, 6MM



Item Code	Description
07-CG-06	KILLIAN CLAUS NASAL GOUGE, 17CM, 6MM



Item Code 07-CG-07 Description COTTLE GUBISCH CHISEL, 18CM, 5MM, GRADUATED, HOLLOW CUT

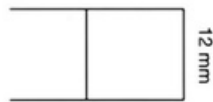
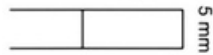

Item Code 07-CG-08 Description COTTLE GUBISCH CHISEL, 18CM, 12MM, GRADUATED, HOLLOW CUT



Item Code Description
07-CG-09 COTTLE CHISEL, 18CM, 4MM, CROSS BAR, GRADUATED

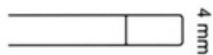
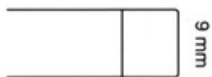

07-CG-10 COTTLE CHISEL, 18CM, 7MM, CROSS BAR, GRADUATED

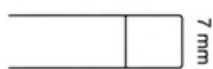
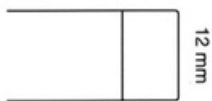

07-CG-11 COTTLE CHISEL, 18CM, 9MM, CROSS BAR, GRADUATED

07-CG-12 COTTLE CHISEL, 18CM, 12MM, CROSS BAR, GRADUATED



Item Code Description
07-CG-13 COTTLE CHISEL, 18CM, 16MM, FISHTAIL SHAPED END, CROSSBAR,

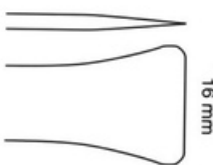

Item Code Description
07-CG-14 RUBIN EDGED BONE CHISEL, 18CM, 8/12MM, T SHAPE

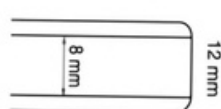
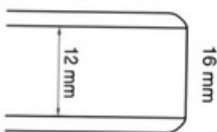

07-CG-15 RUBIN EDGED BONE CHISEL, 18CM, 10/14MM, T SHAPE

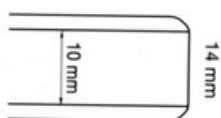

07-CG-16 RUBIN EDGED BONE CHISEL, 18CM, 12/16MM, T SHAPE

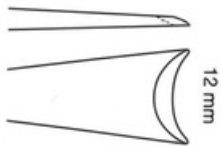
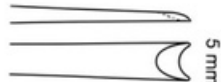
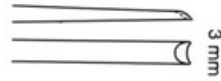

Item Code	Description
07-CG-17	WALTER CHISEL/OSTEOTOME, 19CM, 3MM, MODIFIED
07-CG-18	WALTER CHISEL/OSTEOTOME, 19CM, 5MM, MODIFIED
07-CG-19	WALTER CHISEL/OSTEOTOME, 19CM, 12MM, MODIFIED

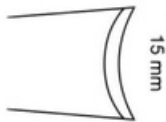
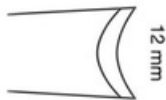

Item Code	Description
07-CG-20	MCINDOE CHISEL, 16CM, 8MM
07-CG-21	MCINDOE CHISEL, 16CM, 10MM
07-CG-22	MCINDOE CHISEL, 16CM, 12MM
07-CG-23	MCINDOE CHISEL, 16CM, 15MM

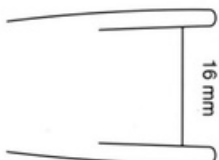

Item Code	Description
07-CG-24	MOBERG CHISEL, 18CM, 10MM
07-CG-25	MOBERG CHISEL, 18CM, 12MM
07-CG-26	MOBERG CHISEL, 18CM, 14MM
07-CG-27	MOBERG CHISEL, 18CM, 16MM



Item CodeDescription

07-CG-28BRAITHWAITE NASAL CHISEL, RIGHT,
5 MM WIDTH, 5 1/2" (140 MM) LENGTH

07-CG-29BRAITHWAITE NASAL CHISEL, LEFT,
5 MM WIDTH, 5 1/2" (140 MM) LENGTH



Item CodeDescription

07-CG-30 CLODIUS BONE CHISEL, 6 MM WIDTH,
8 3/4" (222 MM) LENGTH

07-CG-31 CLODIUS BONE CHISEL, 8 MM WIDTH,
8 3/4" (222 MM) LENGTH

07-CG-32 CLODIUS BONE CHISEL, 10 MM WIDTH,
8 3/4" (222 MM) LENGTH

07-CG-33 CLODIUS BONE CHISEL, 20 MM WIDTH,
8 3/4" (222 MM) LENGTH



Item Code	Description
09-D-02	Humby Dermatomee Knife, Adjustable, Complete with wooden Box, 32cm



Item Code	Description
09-D-03	SPARE BLADE FOR HUMBY AND WATSON DERMATOME



Item Code	Description
09-D-04	WATSON DERMATOME (SKIN GRAFT KNIFE)



Item Code	Description
09-D-05	SCHINK DERMATOME, 30CM, ADJUSTABLE

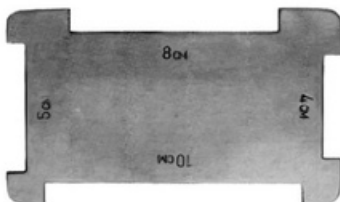

Item Code	Description
09-D-07	SKIN HOLDING/STRETCHING PLATE FOR SCHINK DERMATOME

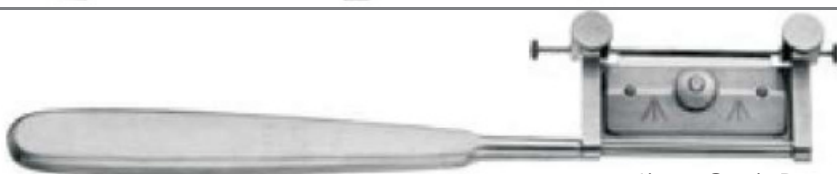

Item Code	Description
09-D-08	SILVER DERMATOME, 19CM, ADJUSTABLE



Item Code	Description
T0-D-01	FRONTOTEMPORAL DISSECTOR, 9" (22.5 CM), 5MM TIP, SLIGHTLY CURVED
T0-D-02	FRONTOTEMPORAL DISSECTOR, 9" (23 CM), 7MM TIP, SLIGHTLY CURVED
T0-D-03	FRONTOTEMPORAL DISSECTOR, 9" (23 CM), 10MM TIP, SLIGHTLY CURVED



Item Code	Description
02-API-03	NAGATA AURICULAR SEPTUM ELEVATOR, 16CM, BLUNT
02-API-04	NAGATA AURICULAR SEPTUM ELEVATOR, 17CM, BLUNT



Item Code	Description
T0-D-04	TEMPORAL T DISSECTOR, 9 1/2" (23.5 CM), 12MM TIP, STRAIGHT



Item Code	Description
T0-D-05	FRONTOGLABELLAR DISSECTOR, 10 1/2" (26.5 CM), 7MM TIP, S SHAPED



Item Code	Description
T0-D-06	ARCUS MARGINALIS DISSECTOR, 9 3/4" (24 CM), 10MM TIP, S SHAPED



Item Code	Description
10-D-07	FLAP DISSECTOR, 9 1/2" (23.5 CM), 5MM TIP, STRAIGHT



Item Code	Description
10-D-08	MIDFACE FACIAL DISSECTOR, 9 3/4" (24 CM), MULTIPLE CURVES, 12MM WIDE TIP



Item Code	Description
10-D-09	ORBITAL RIM DISSECTOR, 9" (22.5 CM), SLIGHTLY CURVED



Item Code	Description
10-D-10	TRANSORAL DISSECTOR, 9 3/4" (23.5 CM), CURVED TIP



Item Code	Description
11-E-03	LANGENBECK BONE ELEVATOR, 20CM, 7MM, BLUNT
11-E-04	LANGENBECK BONE ELEVATOR, 20CM, 10MM, BLUNT



Item Code	Description
11-E-05	LANGENBECK BONE ELEVATOR, 23CM, 10MM, BLUNT, STRONG CURVE

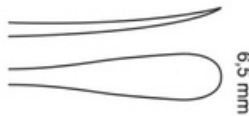
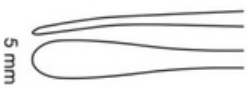

Item Code	Description
11-E-06	FREER PERIOSTEAL ELEVATOR, 19CM, 5MM, DOUBLE ENDED, SHARP / BLUNT
11-E-07	FREER PERIOSTEAL ELEVATOR, 19CM, 6.5MM, DOUBLE ENDED, SHARP / BLUNT

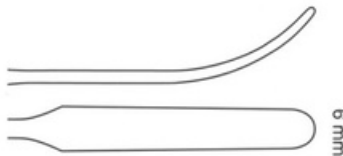

Item Code	Description
11-E-08	COHEN PERIOSTEAL ELEVATOR / RETRACTOR, 24CM, 6MM, DOUBLE ENDED, BLUNT



Item Code	Description
11-E-09	PENNINGTON SEPTUM ELEVATOR, 20CM, DOUBLE ENDED



Item Code	Description
11-E-10	YANKAUER SEPTUM ELEVATOR, 18CM, 6MM, BLUNT



Item Code	Description
11-E-11	COTTLE PERIOSTEAL ELEVATOR, 18CM, 8MM, BLUNT



Item Code	Description
11-E-12	BOIES NASAL FRACTURE ELEVATOR, 19CM, 8MM, BLUNT



Item Code	Description
11-E-13	GOLDMAN SEPTUM FRACTURE ELEVATOR, 17CM, 5MM, BLUNT

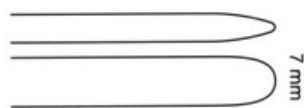

Item Code	Description
11-E-14	NASAL FRACTURE ELEVATOR, 17CM, 7MM, BLUNT



Item Code	Description
11-E-15	SUCTION ELEVATOR WITH GUIDE, 2TCM, 4MM



Item Code	Description
11-E-17	COTTLE PERIOSTEAL ELEVATOR, 20CM, 2/4MM, DOUBLE ENDED, FINE
11-E-19	COTTLE PERIOSTEAL ELEVATOR, 23CM, 3/4MM, DOUBLE ENDED



Item Code	Description
11-E-18	MASING SEPTUM ELEVATOR, 22CM, 5/5MM, DOUBLE ENDED



Item Code	Description
11-E-20	SCALP ELEVATOR, 9 3/4" (24 CM), 12.5MM TIP, SLIGHTLY CURVED
11-E-21	SCALP ELEVATOR, 9 3/4" (24 CM), 15MM TIP, SLIGHTLY CURVED
11-E-22	SCALP ELEVATOR, 9 3/4" (24 CM), 7MM TIP, STRAIGHT
11-E-23	SCALP ELEVATOR, 9 3/4" (24 CM), 12.5MM TIP, S SHAPED
11-E-24	SCALP ELEVATOR, 9 3/4" (24 CM), 12.5MM TIP, SLIGHTLY CURVED
11-E-25	SCALP ELEVATOR, 9 3/4" (24 CM), 7MM TIP, CURVED TIP
11-E-26	SCALP ELEVATOR, 9 3/4" (24 CM), 7MM TIP, STRONGLY CURVED
11-E-27	SCALP ELEVATOR, 9 3/4" (24 CM), 7MM TIP, SLIGHTLY CURVED

Item Code	Description
11-E-28	SCALP ELEVATOR WITH SUCTION, 9 3/4" (24 CM), 7MM WIDE TIP, SLIGHTLY CURVED



Item Code	Description
11-E-29	SCALP ELEVATOR WITH SUCTION, 10 1/2" (26 CM), 8.5 MM WIDE TIP, CURVED TIP



Item Code	Description
11-E-30	PERIOSTEAL ELEVATOR, 10" (25 CM), S SHAPED

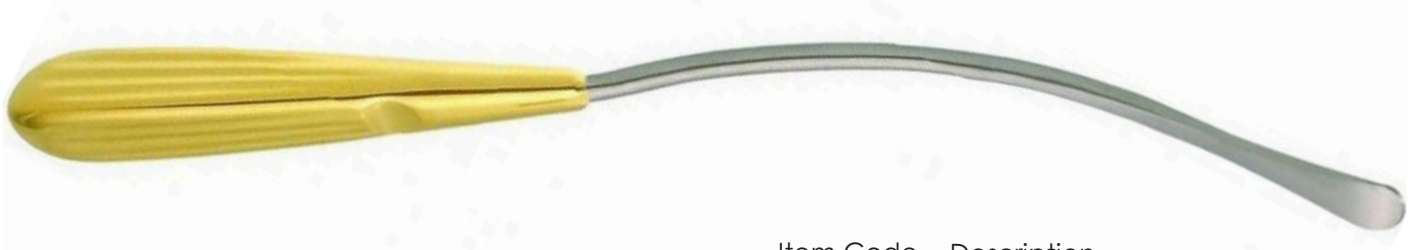

Item Code	Description
11-E-31	PERIOSTEAL SPREADER, 9 3/4" (24 CM), 8MM TIP, S SHAPED



Item Code	Description
11-E-32	PERIOSTEAL SPREADER, 9 3/4" (24 CM), 10MM WIDE BLADE, S SHAPED



Item Code	Description
11-E-33	ZYGOMATIC ARCH ELEVATOR, 8 1/4" (20.5 CM), STRAIGHT BLADE, 5MM



Item Code	Description
11-E-34	HALLE SEPTUM ELEVATOR, NARROW, 3 MM WIDTH, 7" (178 MM) LENGTH



Item Code	Description
11-E-35	FREER SEPTUM ELEVATOR, DOUBLE ENDED, SHARP / BLUNT, WIDE, 6.5 MM WIDTH, 7 3/4" (197 MM) LENGTH



Item Code	Description
11-E-36	HAJEK BALLENGER SEPTUM ELEVATOR, DOUBLE ENDED, 8.5 MM WIDTH, 7 1/2" (191 MM) LENGTH



Item Code	Description
11-E-37	FREER SEPTUM ELEVATOR, CURVED, DOUBLE ENDED, 5 MM WIDTH, 7 1/2" (191 MM) LENGTH



Item Code	Description
11-E-38	KILLIAN SEPTUM ELEVATOR, DOUBLE ENDED, 4 MM WITH 3.4 MM TAPER, AND 4.3 MM WITH 3 MM TAPER, 7 1/4" (184 MM) LENGTH



Item Code	Description
11-E-39	GRUBER COMBINATION KNIFE HANDLE / PERICHONDRIUM ELEVATOR #7, 6 1/2" (165 MM) LENGTH, 10/15C BLADE SIZE



Item Code	Description
11-E-40	HOWARTH SEPTUM ELEVATOR, DOUBLE ENDED, 5 MM WIDTH, 8 1/2" (216 MM) LENGTH

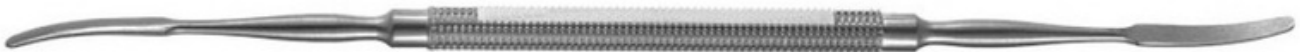

Item Code	Description
11-E-41	KILLIAN SEPTUM ELEVATOR, DOUBLE ENDED, 9" (229 MM) LENGTH, 6 MM WITH 4.5 MM TAPER AND 4.3 MM WITH 3 MM TAPER

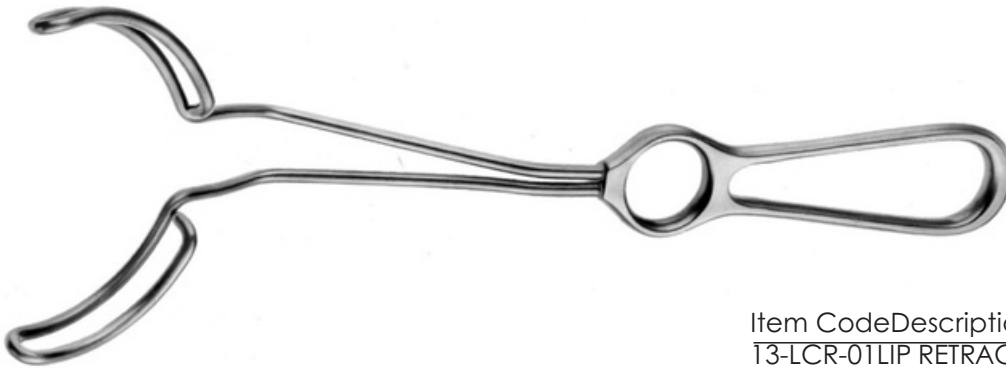

Item CodeDescription
T3-LCR-01LIP RETRACTOR FOR UPPER JAW, 21CM



Item CodeDescription
T3-LCR-02LIP RETRACTOR FOR LOWER JAW, 26CM



Item CodeDescription
T3-LCR-03VESTIBULUM (UNIVERSAL) RETRACTOR,
15CM

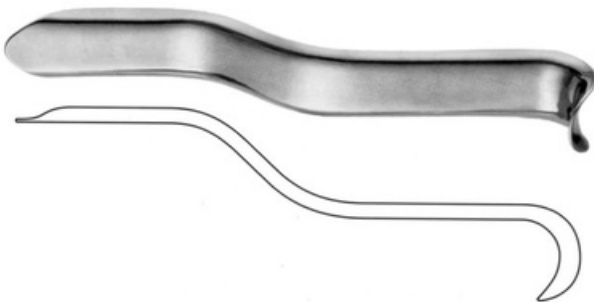

Item CodeDescription
T3-LCR-04UNIVERSITY OF MINNESOTA CHEEK
RETRACTOR, 15.5CM

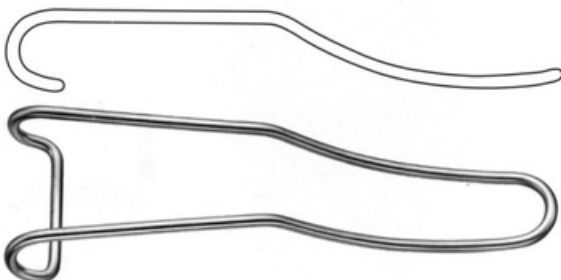

Item CodeDescription
T3-LCR-05STERNBERG CHEEK RETRACTOR, 14.5CM

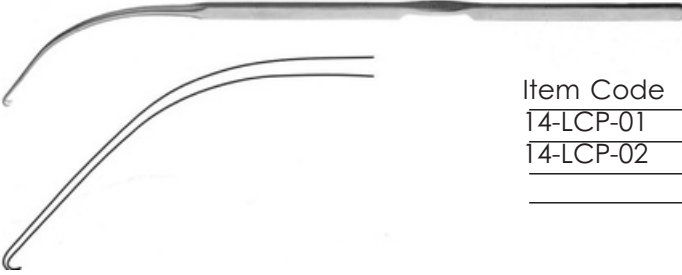

Item Code	Description
T4-LCP-01	BLOCKSMA CLEFT PALATE HOOK, 18CM, 1 PRONG
T4-LCP-02	BLOCKSMA CLEFT PALATE HOOK, 18CM, 3MM, 2 PRONG



Item Code	Description
T4-LCP-03	CLEFT PALATE RASPATORY, 14CM, #1 LEFT
T4-LCP-04	CLEFT PALATE RASPATORY, 14CM, #2 RIGHT



Item Code	Description
T4-LCP-05	KAHRE CLEFT PALATE RASPATORY, 17CM

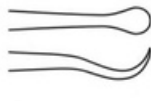
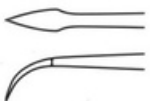

Item Code	Description
T4-LCP-06	MCINDOE CLEFT PALATE RASPATORY, 16.5CM

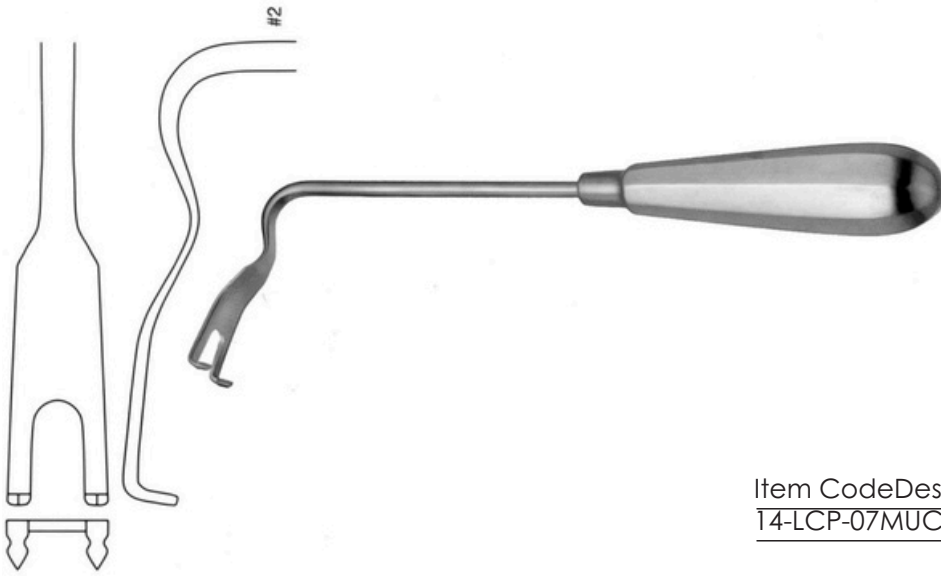

Item Code	Description
T4-LCP-07	MUCOPERIOSTEAL RETRACTOR, 19CM



Item Code	Description
T4-LCP-10	WANG CLEFT PALATE ELEVATOR, 15.5CM

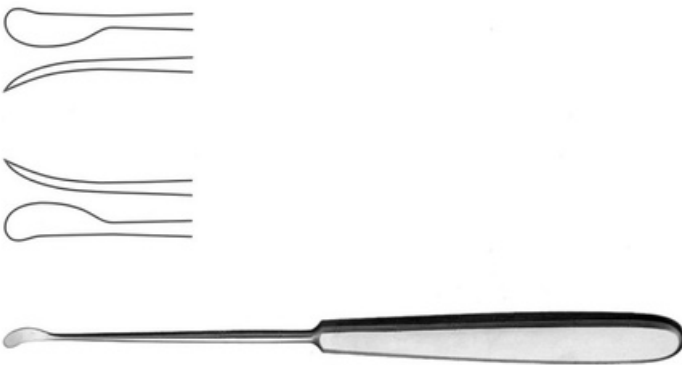

Item Code	Description
T4-LCP-11	WANG CLEFT PALATE ELEVATOR, 18CM, RIGHT
T4-LCP-12	WANG CLEFT PALATE ELEVATOR, 18CM, LEFT
T4-LCP-13	WANG CLEFT PALATE ELEVATOR, 18CM, RIGHT ANGLED
T4-LCP-14	WANG CLEFT PALATE ELEVATOR, 18CM, LEFT ANGLED

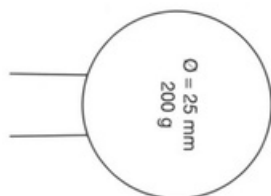

Item Code	Description
15-M-01	MALLET, 18.5CM, PLASTIC FACINGS, 200 GRAMS, 25MM DIAMETER



Item Code	Description
15-M-03	MALLET, 26CM, NOVOTEX PLASTIC, 150 GRAMS, 35MM DIAMETER
15-M-04	MALLET, 26CM, NOVOTEX PLASTIC, 240 GRAMS, 45MM DIAMETER
15-M-05	MALLET, 26CM, NOVOTEX PLASTIC, 330 GRAMS, 50MM DIAMETER



Item Code	Description
15-M-06	COTTLE MALLET, 19CM, 1 PLAIN FACE, 1 CONVEX FACE



Item Code	Description
15-M-07	QUILLEN METAL HAMMER, 24CM, 300 GRAMS, 30MM DIAMETER, ANGLED FACES

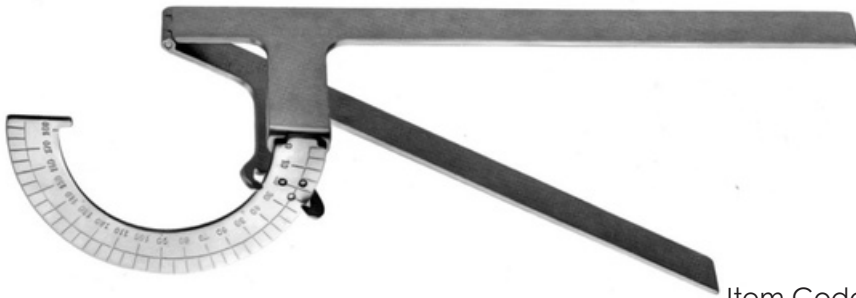

Item CodeDescription
T6-MM-05MOLTGEN FLEXOMETER, 24CM

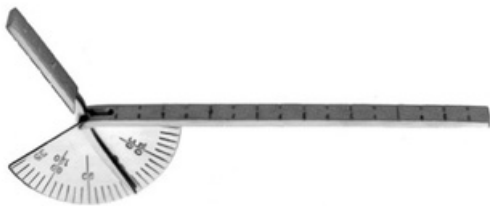

Item CodeDescription
T6-MM-06FINGER GONIOMETER, 13CM



Item CodeDescription
T6-MM-07KNOCHEN MESSZIRKEL BONE BOW
 SPACER, 19.5CM, SHARP TIPS

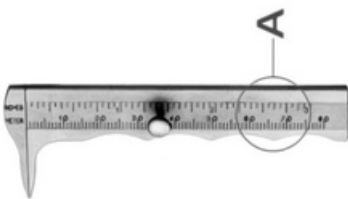

Item CodeDescription
T6-MM-10JAMESON CALIPER, 10CM



Item Code Description
T6-MM-11 THORPE CALIPER, 11CM, 80MM
 MEASURING RANGE



Item Code	Description
16-MM-12	CASTROVIEJO CALIPER, 8CM, 20MM MEASURING RANGE



Item Code	Description
16-MM-13	CASTROVIEJO CALIPER, 9CM, 40MM MEASURING RANGE



Item Code	Description
16-MM-14	CASTROVIEJO EPKER CALIPER, 18CM, STRAIGHT, 40MM MEASURING RANGE



Item Code	Description
16-MM-15	CASTROVIEJO EPKER CALIPER, 18CM, ANGLED, 40MM MEASURING RANGE

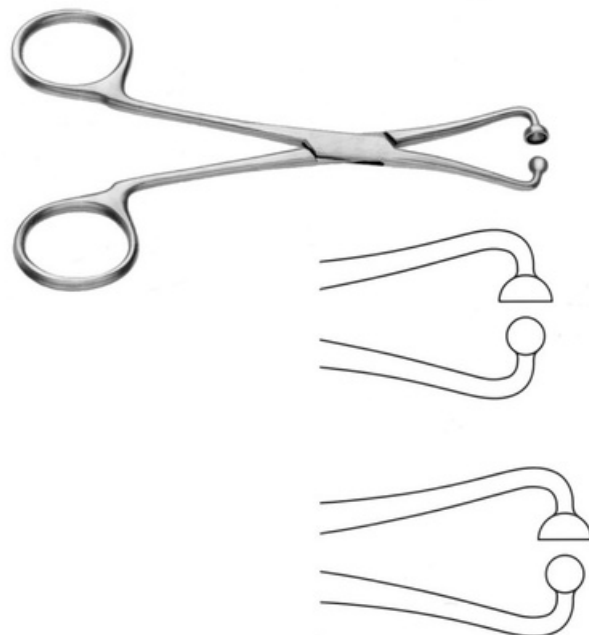

Item Code	Description
16-MM-16	NOSE TIP MARKER, 12CM, STRAIGHT
16-MM-17	NOSE TIP MARKER, 14.5CM, STRAIGHT



Item Code	Description
16-MM-18	JOSEPH MEASURING ROD, 17CM, GRADUATED IN MILLIMETERS

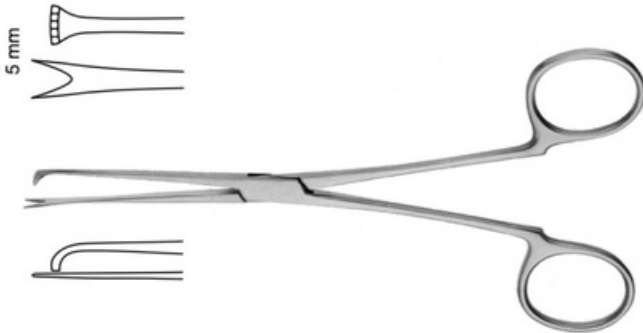

Item Code	Description
16-MM-19	PITANGUY FACELIFT MARKER, 16CM, 5MM WIDE



Item Code	Description
16-MM-34	MARTEN FLAP MARKER, 5 3/4" (14.5 CM)
16-MM-35	MARTEN FLAP MARKER, WITH RATCHET, 5 3/4" (14.5 CM)



Item Code	Description
16-MM-43	D ASSUMPCAO ABDOMINAL FLAP MARKER, 10 MM WIDTH, 10" (254 MM) LENGTH



Item Code	Description
16-MM-44	LOCKWOOD ABDOMINAL DEMARCATOR, 11 MM WIDTH, WITH ANGLED HINGE, 12 1/4" (311 MM) LENGTH

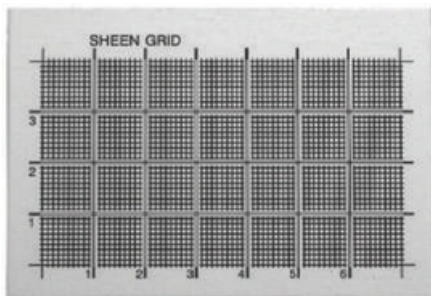

Item Code	Description
16-MM-45	Sheen Grid Stainless Steel, Autoclavable, Grid Dimensions are 40 X 70 mm



Item Code	Description
01-AR-01	ROUND BOWL FOR SOLUTIONS/MARKING COLOR, 60X30MM, 60CC

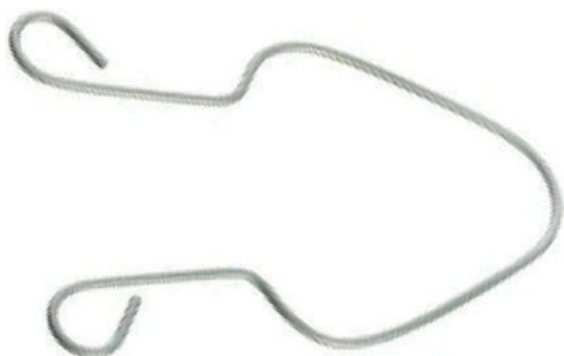

Item Code	Description
01-AR-16	ACKERMAN BREAST MARKER, 5 1/2" (14 CM), SMALL
01-AR-17	ACKERMAN BREAST MARKER, 6 1/4" (16 CM), LARGE



Item Code	Description
01-AR-38	MCKISSOCK KEYHOLE PATTERN, 38 MM DIAMETER, WITH CM MARKINGS
01-AR-39	MCKISSOCK KEYHOLE PATTERN, 42 MM DIAMETER, WITH CM MARKINGS
01-AR-40	MCKISSOCK KEYHOLE PATTERN, 45 MM, DIAMETER, WITH CM MARKINGS

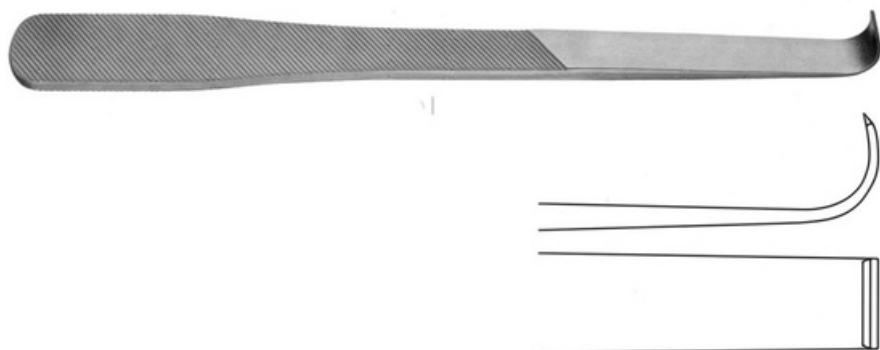

Item Code	Description
17-MM-01	OBWEGESER MAXILLA MOBILIZING INSTRUMENT, 23CM, 12MM



Item Code	Description
18-MG-01	MOLT MOUTH GAG, 10CM, CHILD SIZE
18-MG-02	MOLT MOUTH GAG, 15CM, ADULT SIZE

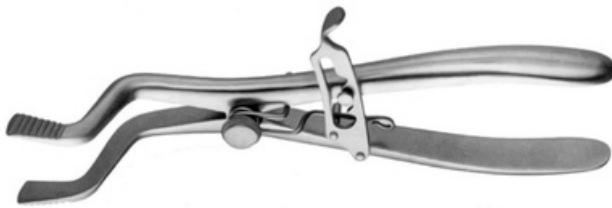

Item Code	Description
18-MG-03	ROSER KOENIG MOUTH GAG, 16CM



Item Code	Description
18-MG-04	DENHART MOUTH GAG, 13CM

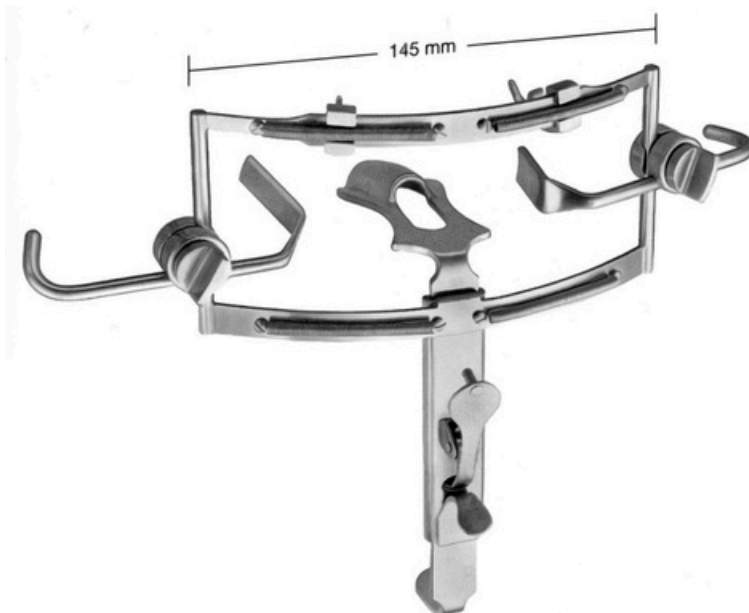

Item Code	Description
18-MG-05	DINGMAN MOUTH GAG, COMPLETE

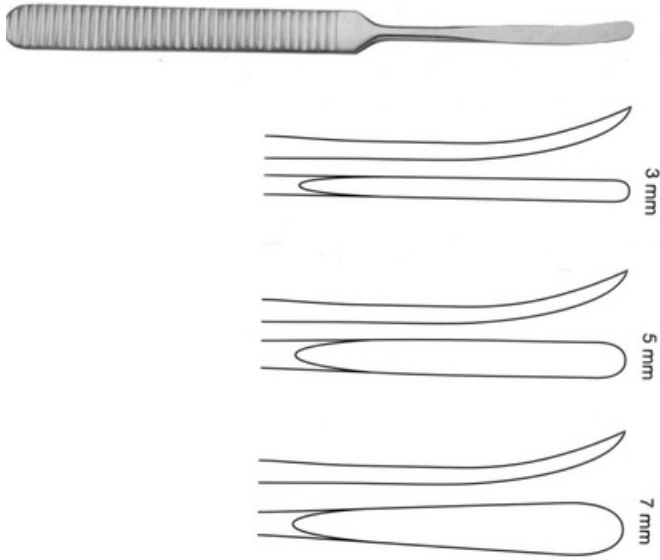

Item Code	Description
19-MKR-01	WILLIGER RASPATORY, 16CM, 3MM, SHARP
19-MKR-02	WILLIGER RASPATORY, 16CM, 5MM, SHARP
19-MKR-03	WILLIGER RASPATORY, 16CM, 7MM, SHARP

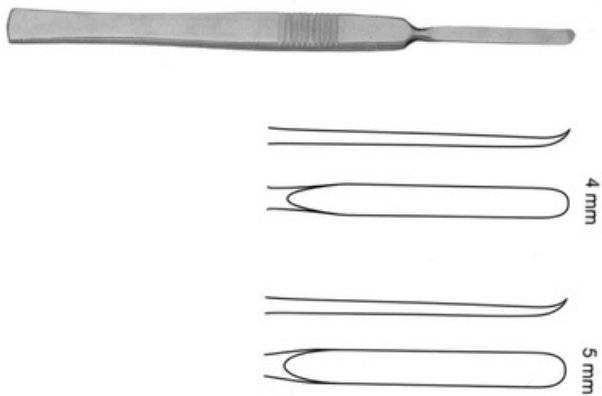

Item Code	Description
19-MKR-04	MCKENTY RASPATORY, 15CM, 4MM, SHARP, LIGHT CURVE
19-MKR-05	MCKENTY RASPATORY, 15CM, 5MM, SHARP, LIGHT CURVE



Item Code	Description
19-MKR-06	FREER MUCOSA END KNIFE, 6" (15 CM)



Item Code	Description
20-NDF-01	HARTMANN NASAL DRESSING FORCEPS, 16CM



Item Code	Description
20-NDF-03	WESTMACOTT NASAL DRESSING FORCEPS, 20CM, STANDARD
20-NDF-04	WESTMACOTT NASAL DRESSING FORCEPS, 20CM, DELICATE

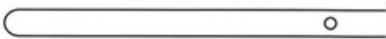

Item Code	Description
20-NDF-05	LUBET BARBON NASAL DRESSING FORCEPS, 20CM

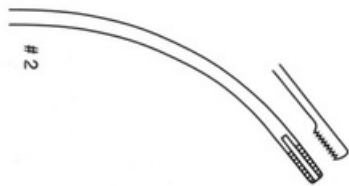
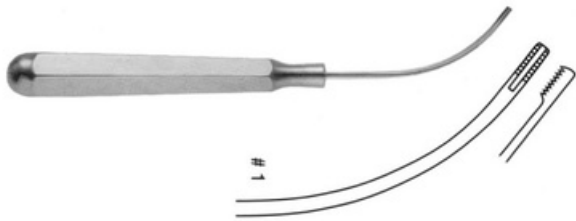

Item Code	Description
21-NFR-01	DINGMAN CARTILAGE ABRADERS, SET OF TWO
21-NFR-02	DINGMAN CARTILAGE ABRADER #1, 15CM, CURVED LEFT
21-NFR-03	DINGMAN CARTILAGE ABRADER #2, 15CM, CURVED RIGHT

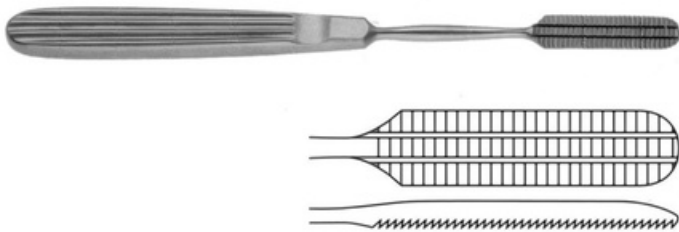

Item Code	Description
21-NFR-04	MALTZ NASAL RASP, 18.5CM



Item Code	Description
21-NFR-05	LEWIS NASAL RASP, 20CM

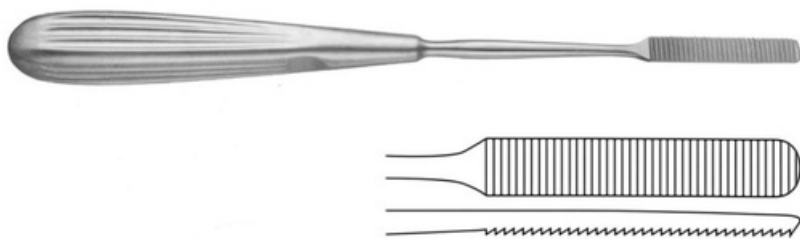

Item Code	Description
21-NFR-06	COTTLE NASAL RASP, 21CM

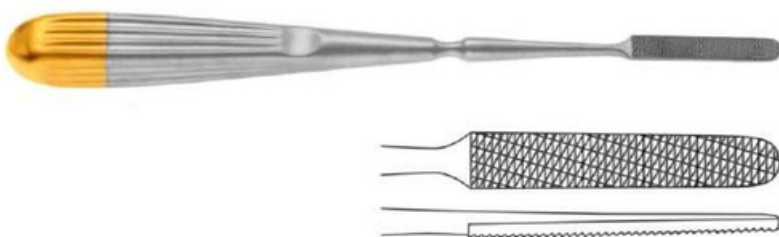

Item Code	Description
21-NFR-07	COTTLE T.C. NASAL RASP, 20.5CM

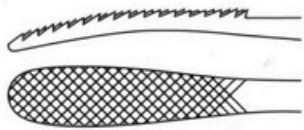
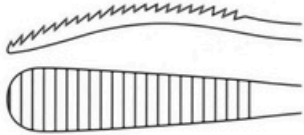
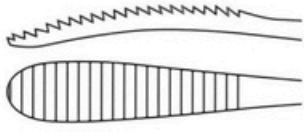

Item Code	Description
21-NFR-08	AUFRICHT NASAL RASP, 21CM, CROSS CUT
21-NFR-09	AUFRICHT NASAL RASP, 21CM, DOWN 21-
NFR-10	AUFRICHT NASAL RASP, 21CM, UP

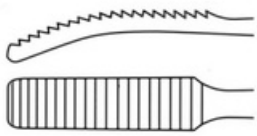

Item Code	Description
21-NFR-11	NASAL RASP, 19.5CM, UP

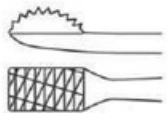

Item Code	Description
21-NFR-12	LEWIS T.C. NASAL RASP, 19.5CM

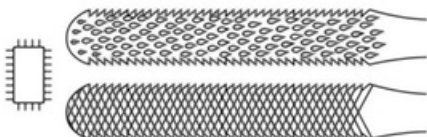

Item Code	Description
21-NFR-13	FOMON BONE AND NASAL RASP, 20CM

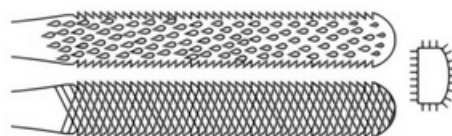

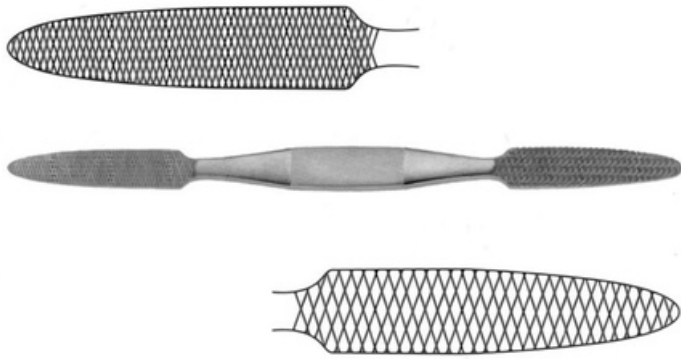

Item Code	Description
21-NFR-14	CONVERSE BONE AND NASAL FILE, 18.5CM

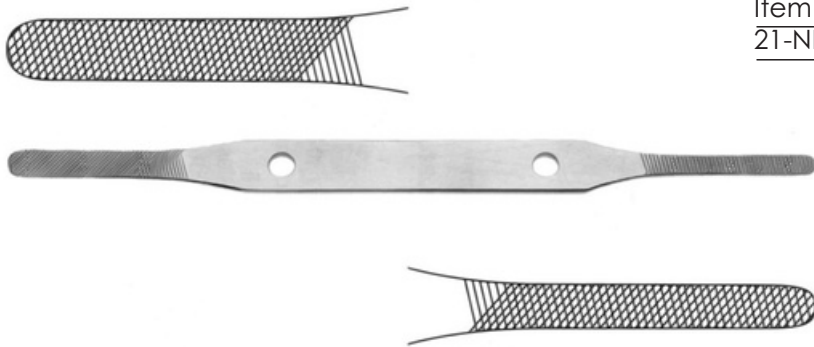

Item Code	Description
21-NFR-15	MASING NASAL FILE, 21CM, FINE

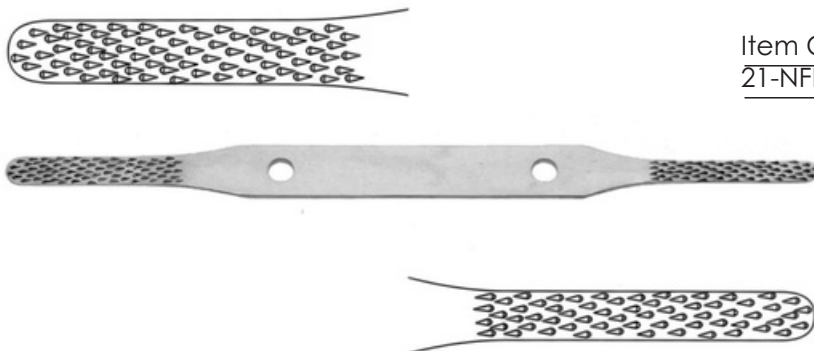

Item Code	Description
21-NFR-16	MASING NASAL RASP, 21CM, COARSE

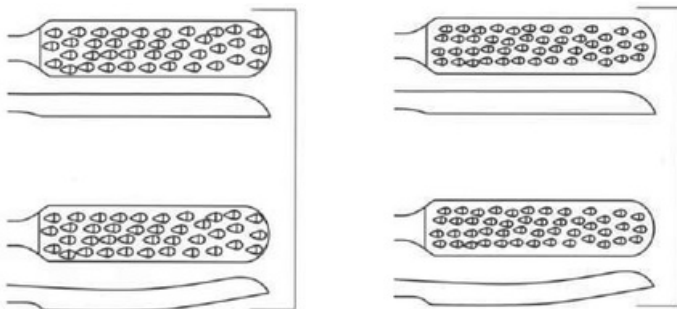

Item Code	Description
21-NFR-17	OBWEGESER NASAL RASP, 19.5CM, FLAT, FINE, DELICATE PATTERN
21-NFR-18	OBWEGESER NASAL RASP, 19.5CM, FLAT, MEDIUM FINE
21-NFR-19	OBWEGESER NASAL RASP, 19.5CM, CONVEX, FINE, DELICATE PATTERN
21-NFR-20	OBWEGESER NASAL RASP, 19.5CM, CONVEX, MEDIUM FINE
21-NFR-21	OBWEGESER NASAL RASP, 19.5CM, V SHAPED, FINE, DELICATE PATTERN
21-NFR-22	OBWEGESER NASAL RASP, 19.5CM, V SHAPED, MEDIUM FINE

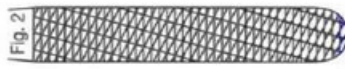
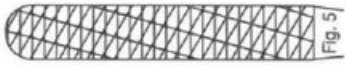

Item Code	Description
21-NFR-23-01	GUBISCH FOMON T.C. NASAL RASP, 20CM, #1 and #2
21-NFR-23-02	GUBISCH FOMON T.C. NASAL RASP, 20CM, #3 and #4
21-NFR-23-03	GUBISCH FOMON T.C. NASAL RASP, 20CM, #5 and #6
21-NFR-23-04	GUBISCH FOMON T.C. NASAL RASP, 20CM, #7 and #8
21-NFR-23-05	GUBISCH FOMON T.C. NASAL RASP, 20CM, #9 and #10

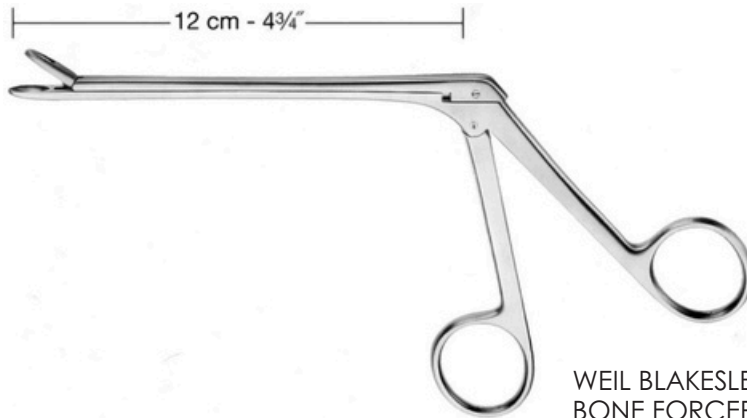

WEIL BLAKESLEY WILDE ETHMOID BONE FORCEP

NORMAL SHAFT



3,0 mm		22-NF-01	22-NF-09	22-NF-16
3,6 mm		22-NF-02	22-NF-10	22-NF-17
4,2 mm		22-NF-03	22-NF-11	22-NF-18
4,8 mm		22-NF-04	22-NF-12	22-NF-19
5,6 mm		22-NF-05		

SLIM SHAFT



3,0 mm		22-NF-23	22-NF-28
3,6 mm		22-NF-24	22-NF-29
4,2 mm		22-NF-25	22-NF-30
4,8 mm		22-NF-26	22-NF-31
5,6 mm		22-NF-27	

11,5 cm - 4½"



WEIL BLAKESLEY FORCEPS,
THROUGH CUT



2,0 mm 

22-NF-06

22-NF-13

2,5 mm 

22-NF-07

22-NF-14

3,0 mm 

22-NF-08

22-NF-15



Item Code	Description
23-NR-01	COTTLE DOUBLE HOOK, 15CM, SHARP, 3X4MM

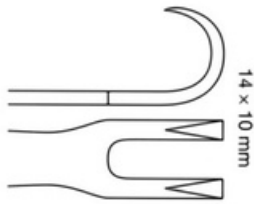

Item Code	Description
23-NR-02	KILNER DOUBLE NASAL HOOK, 10CM, SHARP, 14X10MM

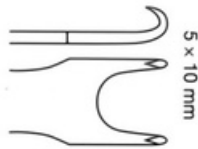

Item Code	Description
23-NR-03	GUBISCH KILNER DOUBLE NASAL HOOK (ALAR RETRACTOR), 8CM, SHARP, 5X10MM

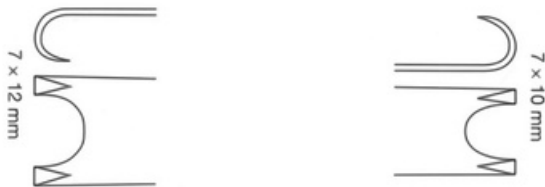

Item Code	Description
23-NR-04	CONVERSE ALAR RETRACTOR, 12CM, DOUBLE ENDED, 7X10MM AND 7X14MM

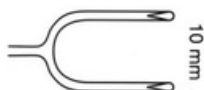

Item Code	Description
23-NR-05	COTTLE ALAR AND SKIN HOOK, 14CM, 2 PRONGS, SHARP, 5X10MM

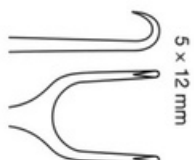

Item Code	Description
23-NR-08	MILLARD COTTLE RETRACTOR WITH FINGER RING, 5.5CM, DOUBLE PRONG, SHARP, 5X12MM

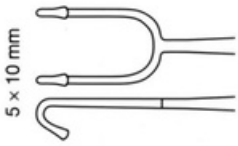

Item CodeDescription

23-NR-09 FOMON RETRACTOR, 17CM, BALL TIPS,
5X10MM

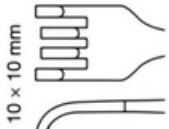

Item CodeDescription

23-NR-10 COTTLE RETRACTOR, 15CM, 4 PRONGS,
BLUNT, 10X10MM

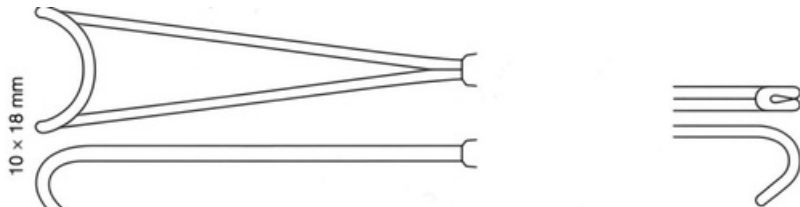

Item CodeDescription

23-NR-11 MASING RETRACTOR, 20CM, WITH
GUIDE CHANNEL, 10X18MM



Item CodeDescription

23-NR-12 NEIVERT RETRACTOR, 19CM, DOUBLE
ENDED, WITH GUIDE CHANNEL, 5X10MM



Item CodeDescription

23-NR-13 COTTLE NEIVERT RETRACTOR, 21CM,
DOUBLE ENDED, 5X10MM



Item CodeDescription

23-NR-14 COTTLE ALAR RETRACTOR, 14CM,
13X12MM

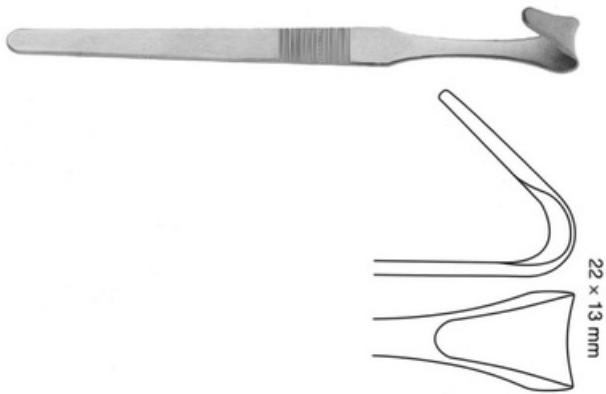

Item Code	Description
23-NR-15	COTTLE ALAR RETRACTOR, 15CM, 22X13MM

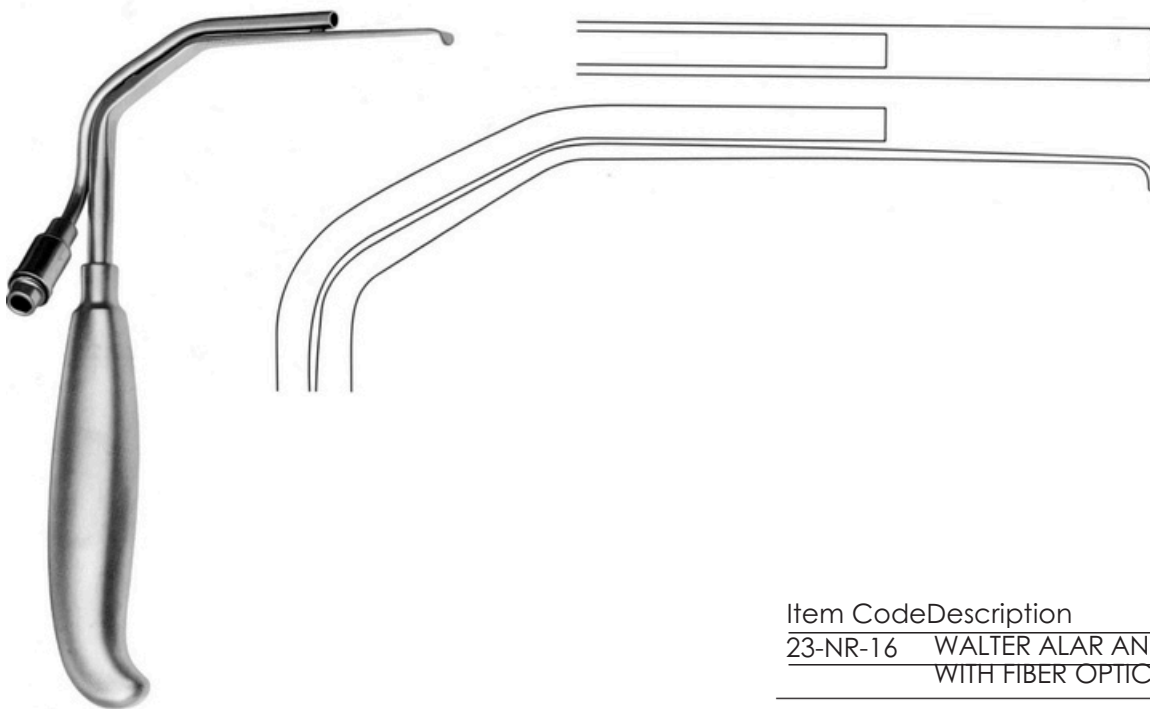

Item Code	Description
23-NR-16	WALTER ALAR AND NASAL RETRACTOR WITH FIBER OPTIC ILLUMINATION, 18.5CM

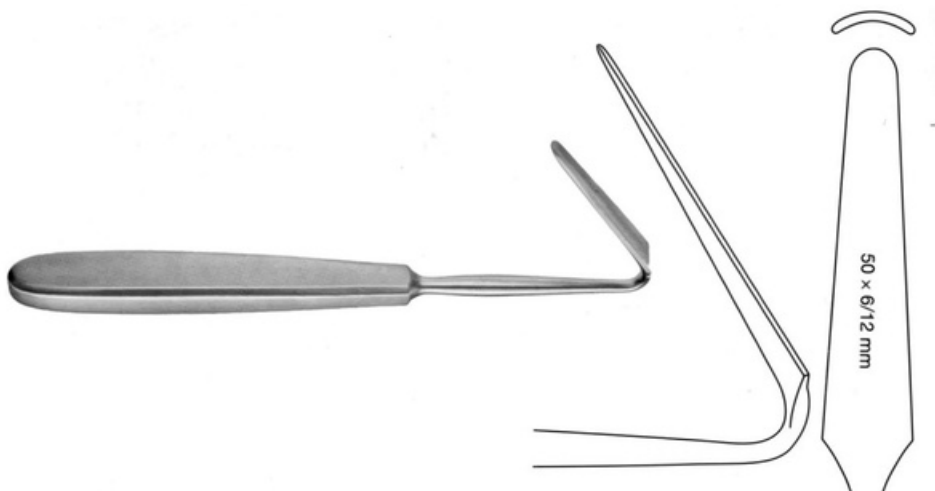

Item Code	Description
23-NR-17	GUBISCH AUFRICHT NASAL RETRACTOR, 17CM, 50X6-12MM

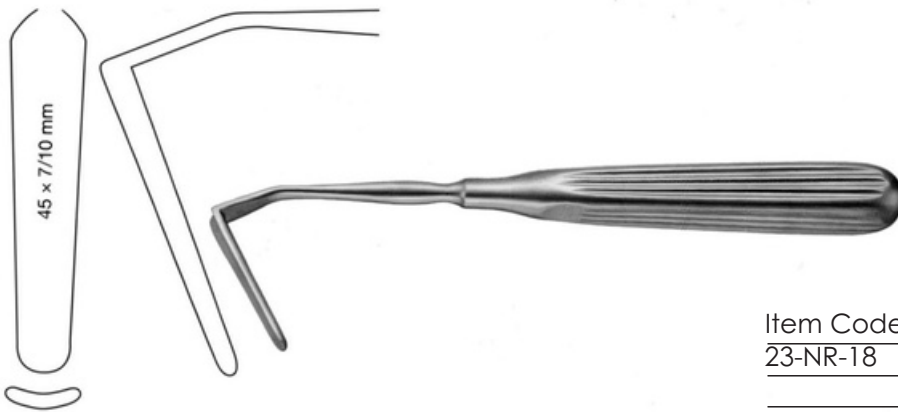

Item Code	Description
23-NR-18	AUFRICT NASAL RETRACTOR, 18CM, 45X7-10MM

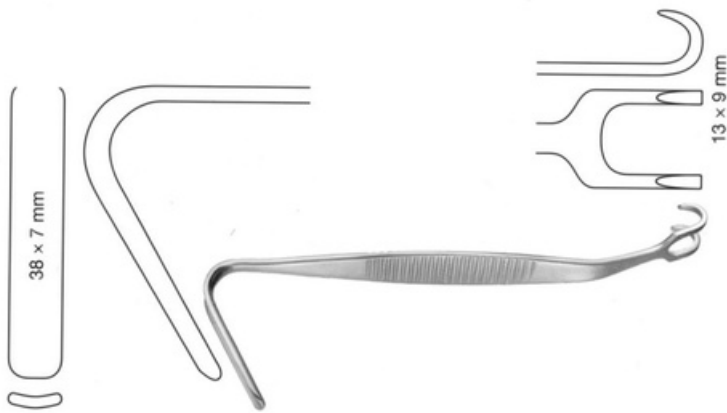

Item Code	Description
23-NR-19	AUFRICT NASAL RETRACTOR, 13.5CM, DOUBLE ENDED, BLUNT, 38X7MM

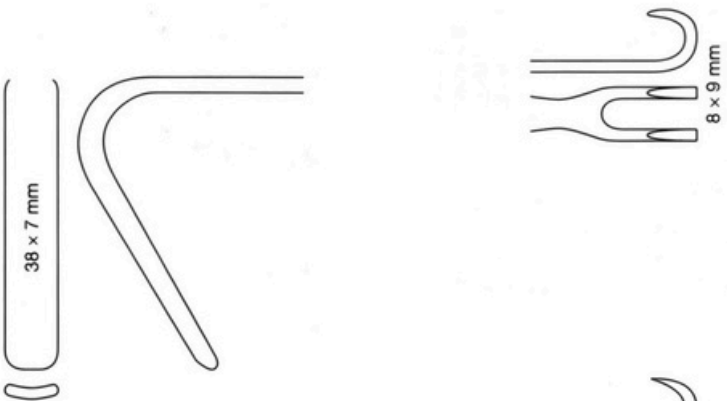

Item Code	Description
23-NR-21	AUFRICT WALTER NASAL RETRACTOR, 13.5CM, DOUBLE ENDED, BLUNT, 38X7MM

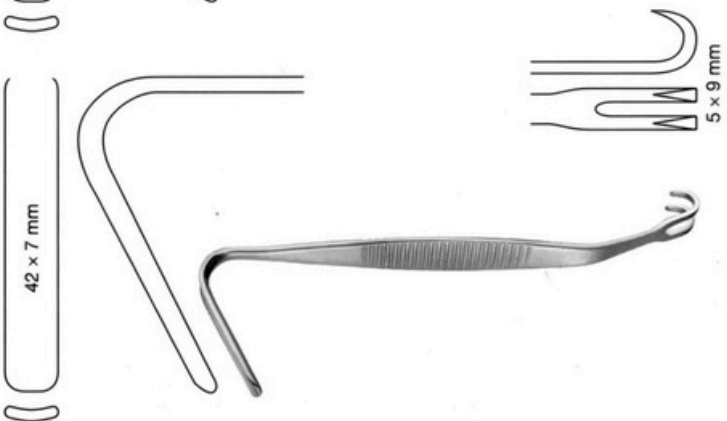

Item Code	Description
23-NR-20	AUFRICT WALTER NASAL RETRACTOR, 13.5CM, DOUBLE ENDED, SHARP, 42X7MM



Item Code	Description
23-NR-22	AUFRICHT NASAL RETRACTOR, 6 1/4" (16CM), 7MM TIP, 45MM BLADE, WITH FIBER OPTIC LIGHT GUIDE
23-NR-24	AUFRICHT NASAL RETRACTOR, 7" (18CM), 10MM TIP, 45MM BLADE, WITH FIBER OPTIC LIGHT GUIDE



Item Code	Description
23-NR-26	CONVERSE BLADE NASAL RETRACTOR, 20MM X 10MM WIDE, WITH FIBER OPTIC LIGHT GUIDE
23-NR-27	CONVERSE BLADE NASAL RETRACTOR, 30MM X 12MM WIDE, WITH FIBER OPTIC LIGHT GUIDE
23-NR-28	CONVERSE BLADE NASAL RETRACTOR, 40MM X 12MM WIDE, WITH FIBER OPTIC LIGHT GUIDE
23-NR-29	CONVERSE BLADE NASAL RETRACTOR, 50MM X 12MM WIDE, WITH FIBER OPTIC LIGHT GUIDE



Item Code	Description
23-NR-34	FOMON NASAL RETRACTOR, 1 BALL END PRONG, 6 1/4" (16 CM)
23-NR-35	FOMON NASAL RETRACTOR, 2 BALL END PRONGS, 6 1/4" (16 CM)



Item Code	Description
R-09-58	Killian Nasal Speculum With Fiber Optics Illumination

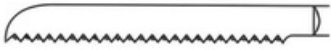

Item Code	Description
24-NS-01	JOSEPH NASAL SAW, 17CM, STRAIGHT

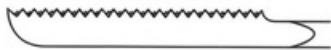
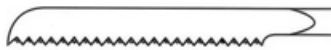

Item Code	Description
24-NS-02	JOSEPH NASAL SAW, 17CM, LEFT
24-NS-03	JOSEPH NASAL SAW, 17CM, RIGHT

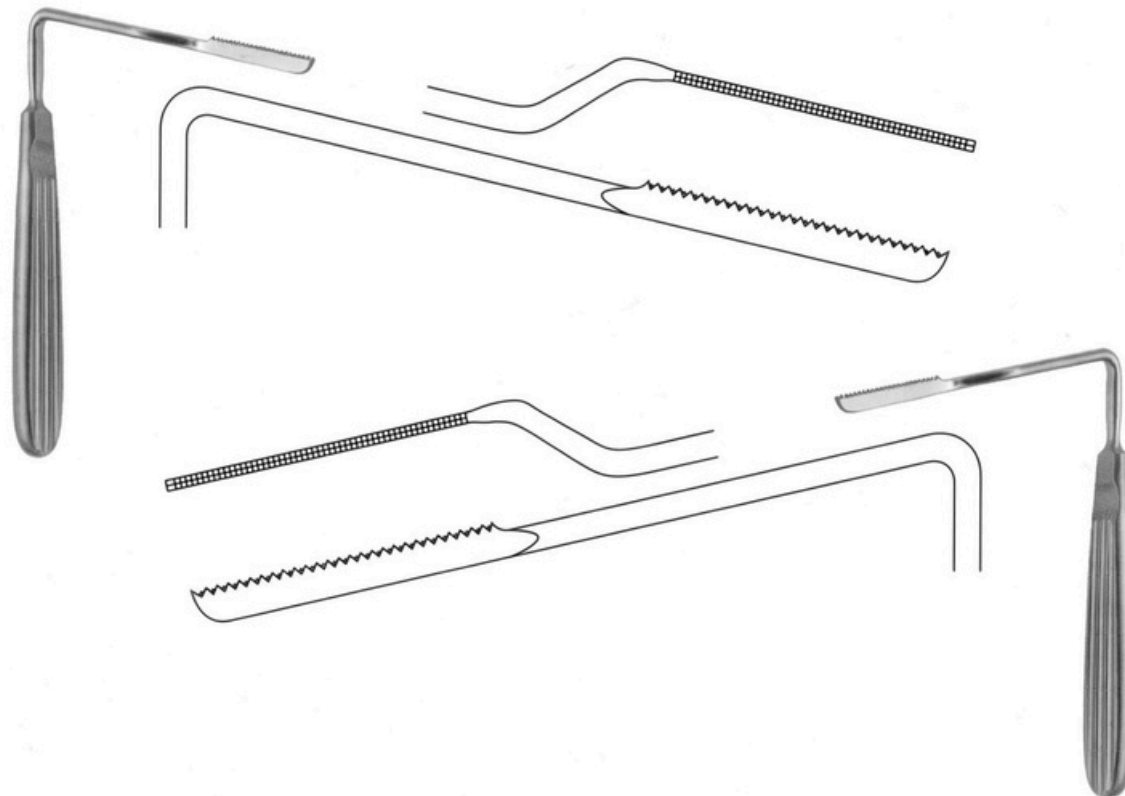

Item Code	Description
24-NS-04	JOSEPH NASAL SAW, ANGLED TO LEFT
24-NS-05	JOSEPH NASAL SAW, ANGLED TO RIGHT

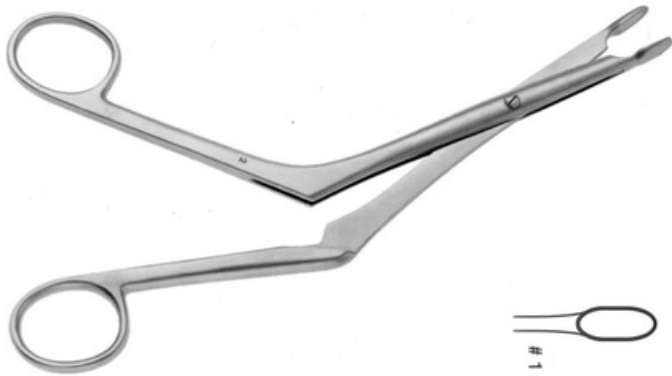

Item Code	Description
25-NSF-01	LUC BRUENINGS HEYMANN ETHMOID FORCEPS 18CM

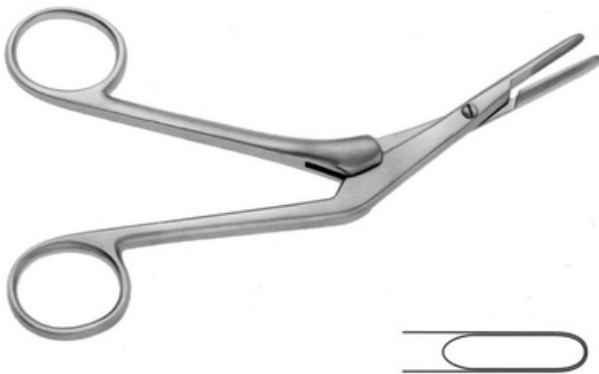

Item Code	Description
25-NSF-03	CRAIG VOMER FORCEPS, 17CM

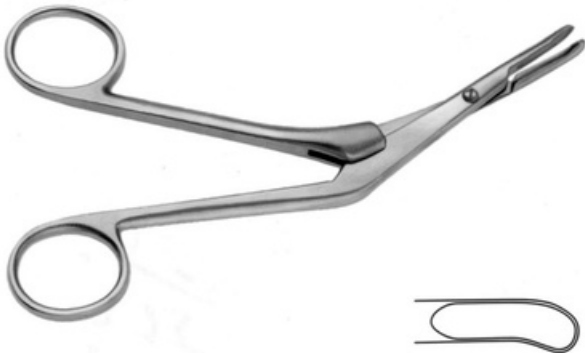

Item Code	Description
25-NSF-04	CRAIG DOMNICK SEPTUM FORCEPS, 17CM, CURVED RIGHT



Item Code	Description
25-NSF-05	CRAIG DOMNICK SEPTUM FORCEPS, 17CM, CURVED LEFT



Item Code	Description
25-NSF-07	OBWEGESER NASAL SEPTUM CUTTER / PERFORATION FORCEPS, 18.5CM

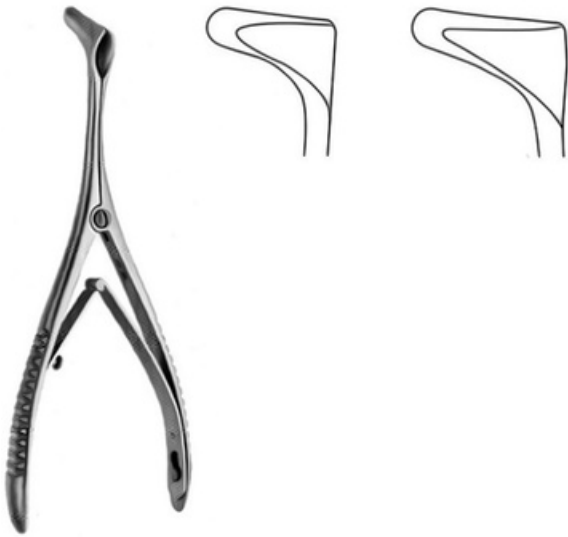

Item Code	Description
26-NS-01	TIECK HALLE NASAL SPECULUM, 13.5CM, FOR BABIES
26-NS-02	TIECK HALLE NASAL SPECULUM, 13.5CM, FOR INFANTS

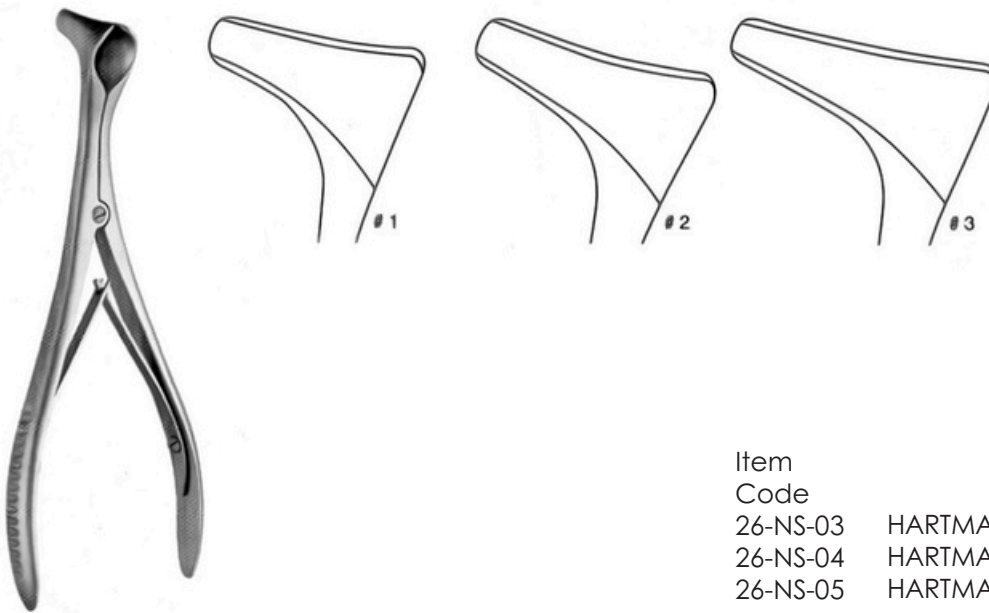

Item Code	Description
26-NS-03	HARTMANN NASAL SPECULUM #1, 15CM
26-NS-04	HARTMANN NASAL SPECULUM #2, 15CM
26-NS-05	HARTMANN NASAL SPECULUM #3, 15CM

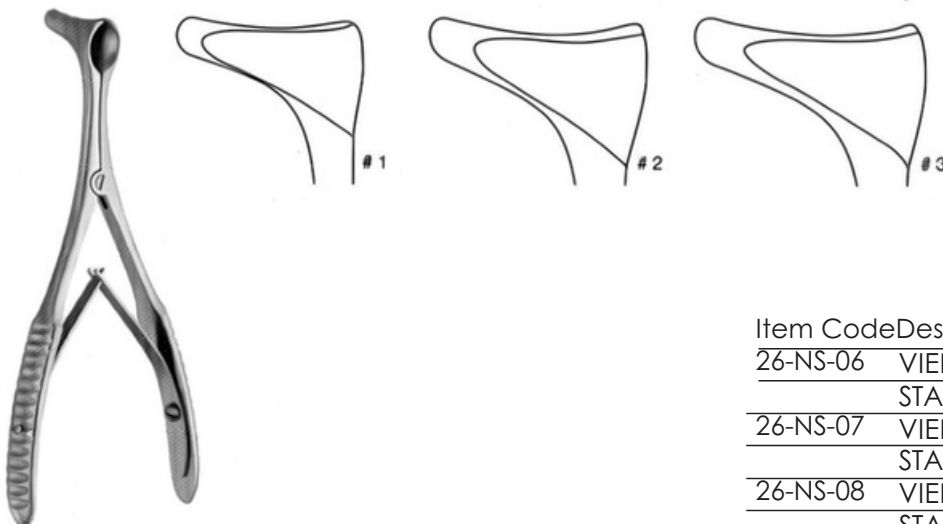

Item Code	Description
26-NS-06	VIENNA MODEL (MODIFIED WIEN) STANDARD NASAL SPECULUM #1, 14CM
26-NS-07	VIENNA MODEL (MODIFIED WIEN) STANDARD NASAL SPECULUM #2, 14CM
26-NS-08	VIENNA MODEL (MODIFIED WIEN) STANDARD NASAL SPECULUM #3, 14CM



Item
Code

26-NS-09	KILLIAN NASAL SPECULUM #1, 14CM, 35MM
26-NS-10	KILLIAN NASAL SPECULUM #2, 14CM, 50MM
26-NS-11	KILLIAN NASAL SPECULUM #3, 14CM, 75MM
26-NS-12	KILLIAN NASAL SPECULUM #4, 14CM, 90MM

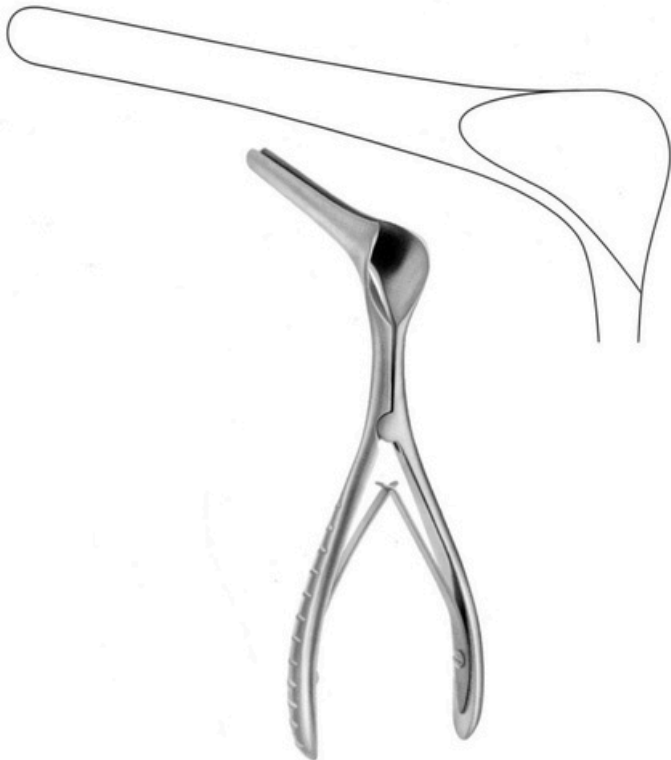

Item CodeDescription

26-NS-13	KILLIAN ASEPT NASAL SPECULUM, #4, 90MM (MODIFIED)
----------	--



Item CodeDescription

26-NS-20	COTTLE COLUMELLA FORCEPS, 11CM
----------	--------------------------------



Item Code	Description
26-NS-14	COTTLE NASAL SPECULUM #1, 14CM, 35MM
26-NS-15	COTTLE NASAL SPECULUM #2, 14CM, 55MM
26-NS-16	COTTLE NASAL SPECULUM #3, 14CM, 75MM
26-NS-17	COTTLE NASAL SPECULUM #4, 14CM, 90MM



Item Code	Description
26-NS-18	COTTLE NASAL SEPTUM SPECULUM, 14CM, 50MM



Item Code	Description
26-NS-19	COTTLE NASAL SPECULUM, DELICATE, 15CM, 55MM

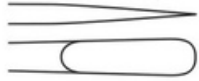

Item Code	Description
29-RK-01	COTTLE NASAL KNIFE, 14CM, STRAIGHT



Item Code	Description
29-RK-02	JOSEPH NASAL KNIFE, 15CM, STRAIGHT, BUTTON END



Item Code	Description
29-RK-03	CONVERSE RHINOPLASTY KNIFE, 15CM, CURVED, BUTTON END



Item Code	Description
29-RK-04	COTTLE DOUBLE EDGED KNIFE, 15CM, STRAIGHT

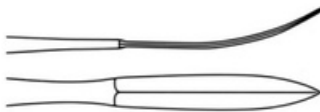

Item Code	Description
29-RK-05	JOSEPH DOUBLE EDGED KNIFE, 15CM, CURVED, SHARP TIP



Item Code	Description
29-RK-06	JOSEPH BUTTON END KNIFE, 16CM, ANGLED

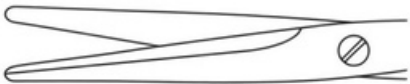
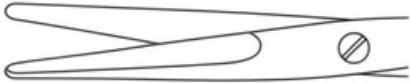

Item Code	Description
30-RS-01-01	HEYMANN NASAL SCISSORS, SUPERCUT, 17CM
30-RS-01-02	HEYMANN NASAL SCISSORS, SUPERCUT, 18CM
30-RS-01-03	HEYMANN NASAL SCISSORS, SUPERCUT, 20CM

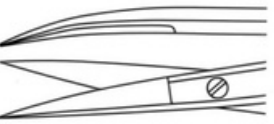
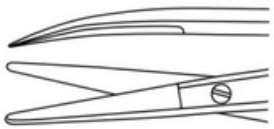

Item Code	Description
30-RS-05-01	COTTLE MASING RHINOPLASTY SCISSORS, 10CM, CURVED BLADE, SHARP
30-RS-05-02	COTTLE MASING RHINOPLASTY SCISSORS, 10CM, CURVED BLADE, BLUNT

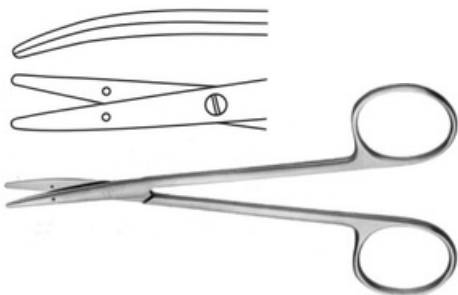

Item Code	Description
30-RS-07	LITTLER SUTURE CARRYING SCISSORS, 12CM

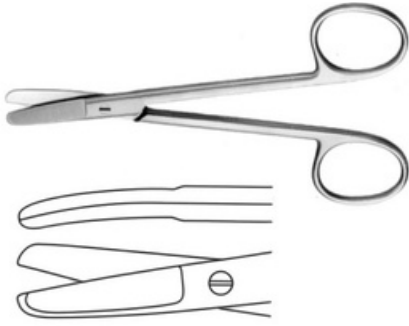

Item Code	Description
30-RS-08	COTTLE BULLDOG SCISSORS, 11.5CM

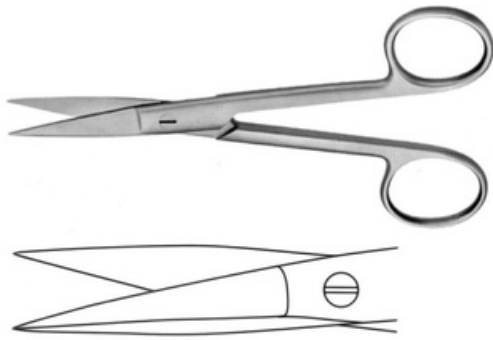

Item Code	Description
30-RS-09	CONVERSE SCISSORS, 13.5CM, DOUBLE EDGED, OUTER EDGES SEMI SHARP

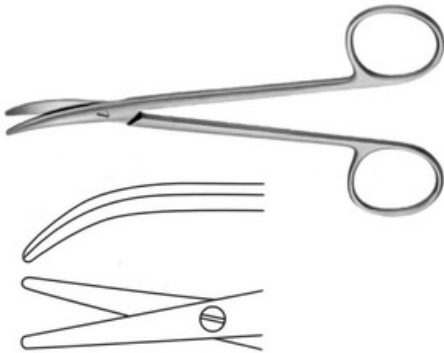

Item Code	Description
30-RS-10	CINELLI RHINOPLASTY SCISSORS, 11CM, OUTER EDGES SEMI SHARP

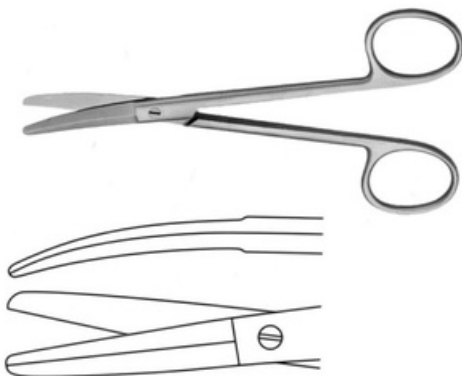

Item Code	Description
30-RS-11	FOMON RHINOPLASTY SCISSORS, 12.5CM, WITH OUTER CUTTING, BOTH SIDES SHARP

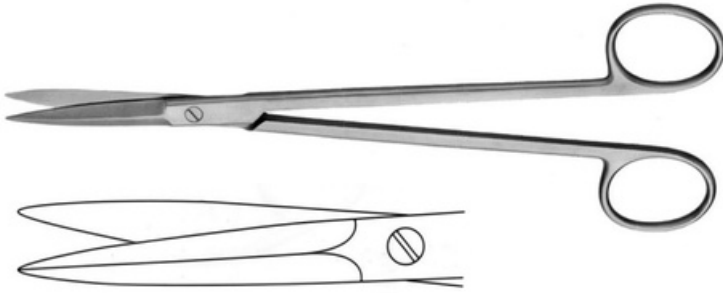

Item Code	Description
30-RS-12	MCINDOE RHINOPLASTY SCISSORS, 19CM, STRAIGHT, SERRATED

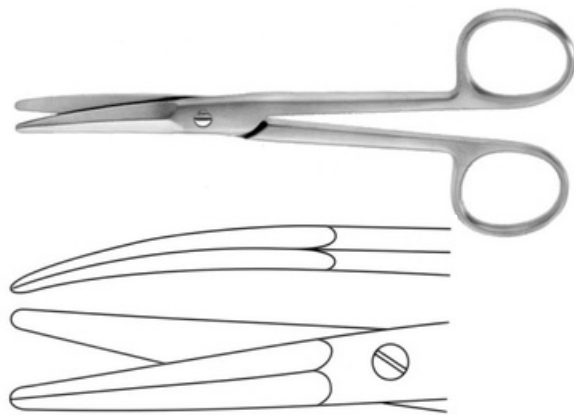

Item Code	Description
30-RS-13-01	AUFRICHT NASAL SCISSORS, 14CM, BLUNT
30-RS-13-02	AUFRICHT NASAL SCISSORS, 14CM, , SUPERCUT
30-RS-13-03	AUFRICHT NASAL SCISSORS, 14CM, BLUNT, TC (TUNGSTEN CARBIDE)
30-RS-13-04	AUFRICHT NASAL SCISSORS, 14CM, BLUNT, SUPERCUT PLUS



Item Code	Description
30-RS-17-01	FOMON RHINOPLASTY SCISSORS, 12CM
30-RS-17-02	FOMON RHINOPLASTY SCISSORS SUPERCUT, 12CM,

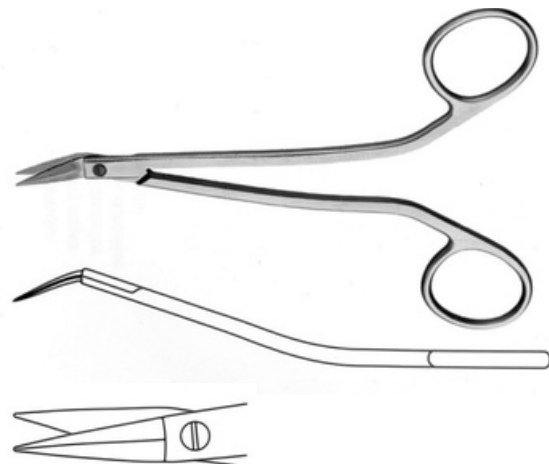

Item Code	Description
30-RS-19	WALTER DORSAL SCISSORS SUPERCUT, 14CM, ANGULAR

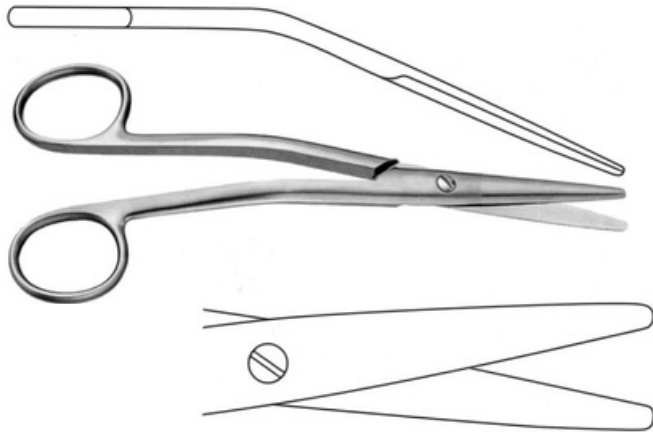

Item Code	Description
30-RS-20-01	COTTLE DORSAL SCISSORS, 16CM, ANGULAR
30-RS-20-02	COTTLE DORSAL SCISSORS, 16CM, ANGULAR, SUPERCUT
30-RS-20-03	COTTLE DORSAL SCISSORS, 16CM, ANGULAR, TC (TUNGSTEN CARBIDE)
30-RS-20-04	COTTLE DORSAL SCISSORS, 16CM, ANGULAR, SUPERCUT PLUS

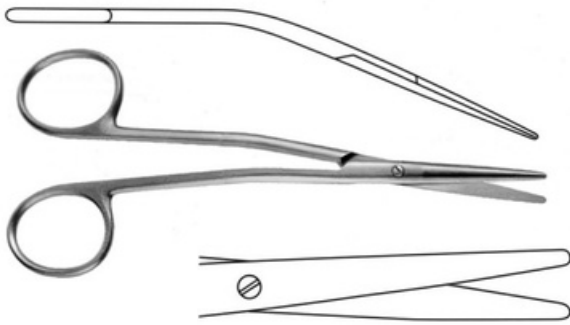

Item Code	Description
30-RS-24-01	FOMON DORSAL SCISSORS, 13CM, ANGULAR
30-RS-24-02	FOMON DORSAL SCISSORS, 13CM, ANGULAR, SUPERCUT
30-RS-24-03	FOMON DORSAL SCISSORS, 13CM, ANGULAR, TC (TUNGSTEN CARBIDE)
30-RS-24-04	FOMON DORSAL SCISSORS, 13CM, ANGULAR, SUPERCUT PLUS

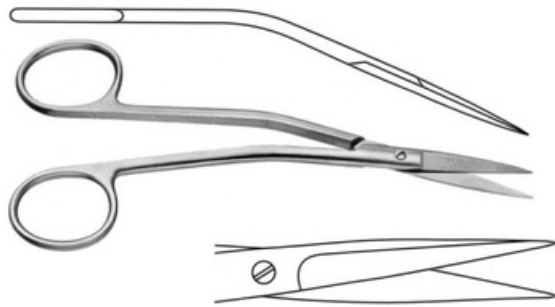

Item Code	Description
30-RS-27-01	FANOUS DORSAL SCISSORS, 14CM
30-RS-27-02	FANOUS DORSAL SCISSORS, 14CM, SUPERCUT

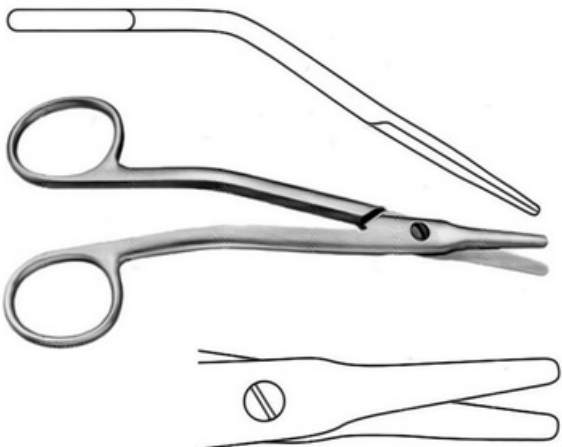

Item Code	Description
30-RS-29-01	WALTER COTTLE DORSAL SCISSORS, 16CM, CURVED
30-RS-29-02	WALTER COTTLE DORSAL SCISSORS, 16CM, CURVED, SUPERCUT
30-RS-29-03	WALTER COTTLE DORSAL SCISSORS, 16CM, CURVED, (TUNGSTEN CARBIDE)
30-RS-29-04	WALTER COTTLE DORSAL SCISSORS, 16CM, CURVED, SUPERCUT PLUS

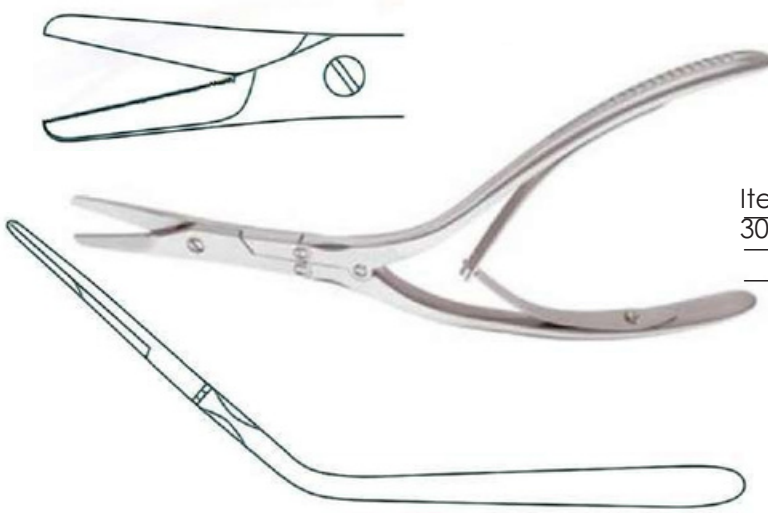

Item Code	Description
30-RS-31	CAPLAN NASAL SEPTUM SCISSORS, 20CM, SERRATED

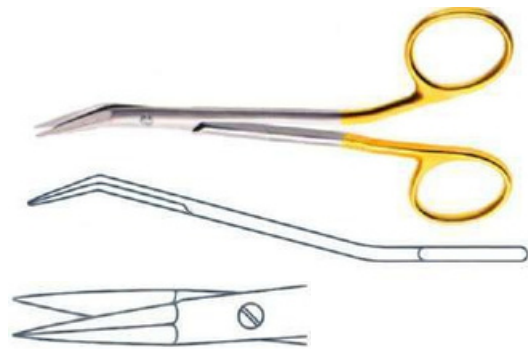

Item Code	Description
30-RS-32	GIUNTA T.C. NASAL SCISSORS, 13.5CM, CURVED



Item Code	Description
31-SSF-01	WALSHAM UNIVERSAL SEPTUM FORCEPS, 23CM

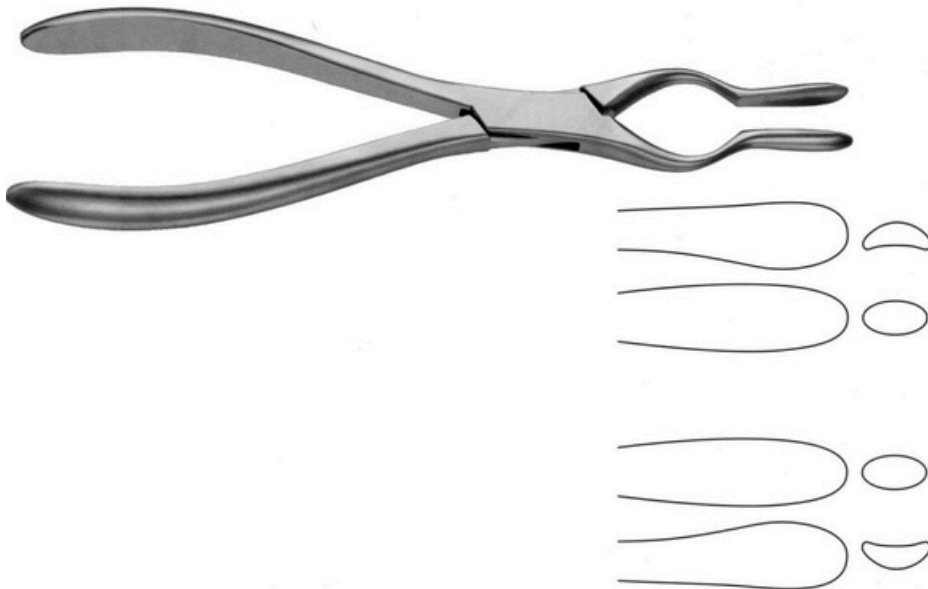

Item Code	Description
31-SSF-02	WALSHAM SEPTUM STRAIGHTENING FORCEPS, 23CM, RIGHT
31-SSF-03	WALSHAM SEPTUM STRAIGHTENING FORCEPS, 23CM, LEFT

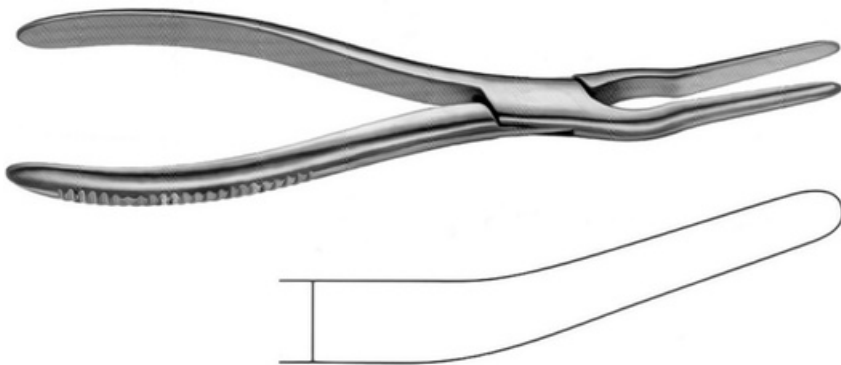

Item Code	Description
31-SSF-06	ASCH SEPTUM STRAIGHTENING FORCEPS, 22CM, ANGLED

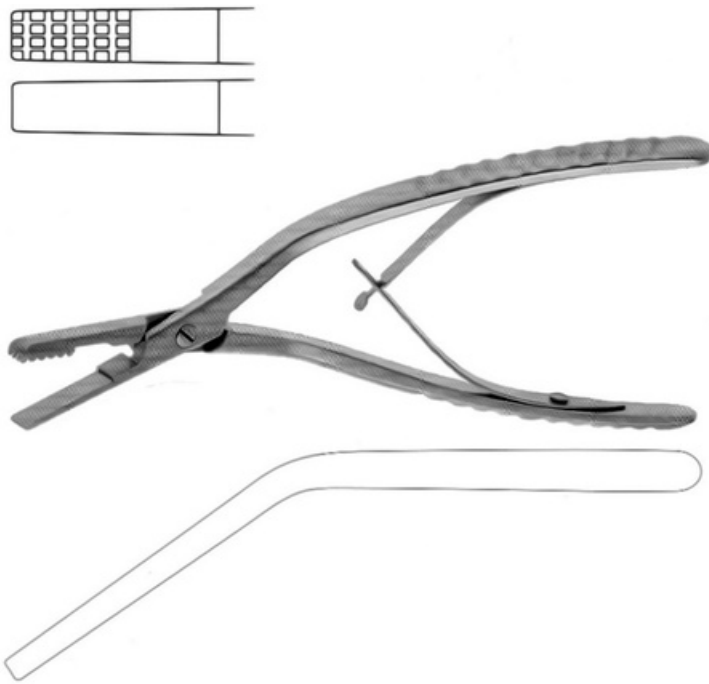

Item Code	Description
25-NSF-07	OBWEGESER NASAL SEPTUM CUTTER / PERFORATION FORCEPS, 18.5CM



Item Code Description

27-O-01 COTTLE OSTEOTOME, 18CM, 4MM, STRAIGHT, GRADUATED

27-O-02 COTTLE OSTEOTOME, 18CM, 7MM, STRAIGHT, GRADUATED

27-O-03 COTTLE OSTEOTOME, 18CM, 9MM, STRAIGHT, GRADUATED

27-O-04 COTTLE OSTEOTOME, 18CM, 12MM, STRAIGHT, GRADUATED



Item Code Description

27-O-05 GUBISCH OSTEOTOME, 18.5CM, 3MM, ALUMINIUM HANDLE

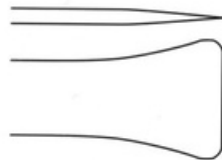

Item Code Description

27-O-06 COTTLE OSTEOTOME, 18CM, 16MM, FISHTAIL SHAPED END, STRAIGHT, GRADUATED



Item Code Description

27-O-07 RUBIN NASAL OSTEOTOME, 18CM, 10MM

RUBIN NASAL OSTEOTOME, 18CM, 14MM



Item Code	Description
27-O-09	COTTLE OSTEOTOME, 18CM, 6MM, CURVED, GRADUATED

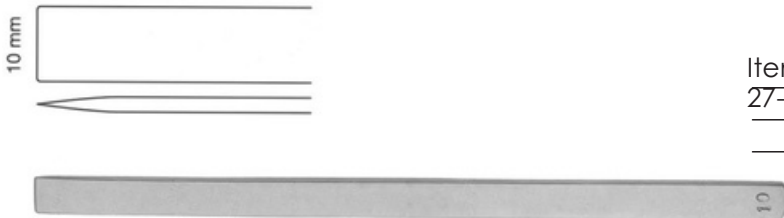

Item Code	Description
27-O-10	COTTLE BONE LEVER/SPLITTING OSTEOTOME, 20CM, 10MM

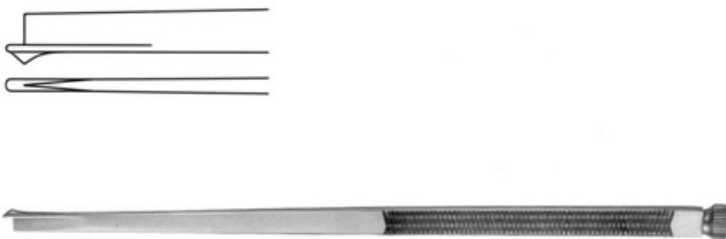

Item Code	Description
27-O-11	GUBISCH FANOUS NASAL OSTEOTOME, 19.5CM, NARROW, DELICATE, WITH GUIDE THORN

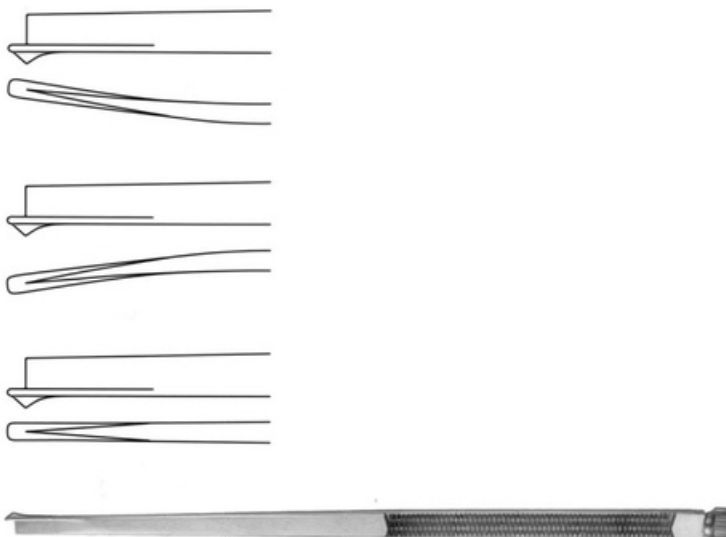

Item Code	Description
27-O-12	FANOUS OSTEOTOME, 19.5CM, 4MM, STRAIGHT, WITH GUIDE THORN
27-O-13	FANOUS OSTEOTOME, 19.5CM, 4MM, LEFT, WITH GUIDE THORN
27-O-14	FANOUS OSTEOTOME, 19.5CM, 4MM, RIGHT, WITH GUIDE THORN

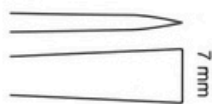
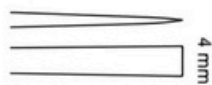
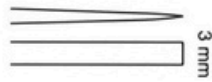
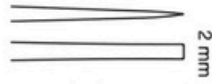
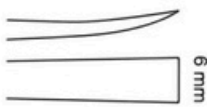
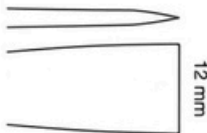
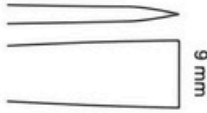

Item Code	Description
-----------	-------------

27-O-15	WALTER OSTEOTOME, 19CM, 2MM
27-O-16	WALTER OSTEOTOME, 19CM, 3MM
27-O-17	WALTER OSTEOTOME, 19CM, 4MM
27-O-18	WALTER OSTEOTOME, 19CM, 7MM
27-O-19	WALTER OSTEOTOME, 19CM, 9MM
27-O-20	WALTER OSTEOTOME, 19CM, 12MM
27-O-21	WALTER OSTEOTOME, 19CM, 6MM, CURVED



Item Code	Description
-----------	-------------

27-O-22	FOMON OSTEOTOME, 17CM, 5MM, STRAIGHT
27-O-23	FOMON OSTEOTOME, 17CM, 7MM, STRAIGHT
27-O-24	FOMON OSTEOTOME, 17CM, 8MM, STRAIGHT

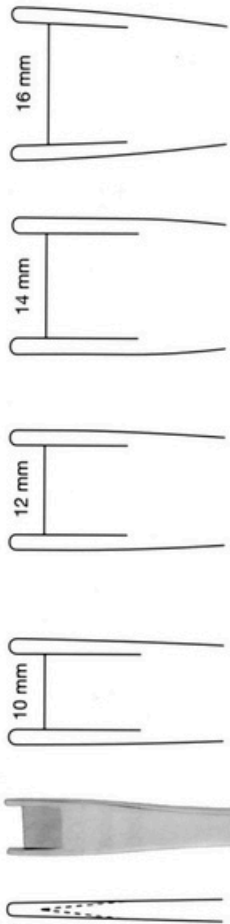

Item Code	Description
27-O-25	CINELLI GUARDED OSTEOTOME, 16CM, 10MM, STRAIGHT
27-O-26	CINELLI GUARDED OSTEOTOME, 16CM, 12MM, STRAIGHT
27-O-27	CINELLI GUARDED OSTEOTOME, 16CM, 14MM, STRAIGHT
27-O-28	CINELLI GUARDED OSTEOTOME, 16CM, 16MM, STRAIGHT

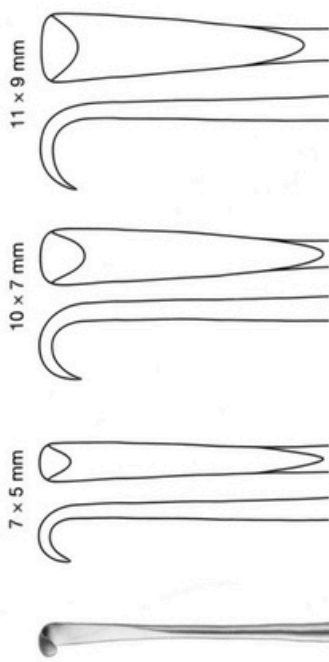

Item Code	Description
28-R-26	OBWEGESER PERIOSTEAL ELEVATOR / RASPATORY, 20CM, 7X5MM, CURVED, SHARP
28-R-27	OBWEGESER PERIOSTEAL ELEVATOR / RASPATORY, 20CM, 10X7MM, CURVED, SHARP
28-R-28	OBWEGESER PERIOSTEAL ELEVATOR / RASPATORY, 20CM, 11X9MM, CURVED, SHARP

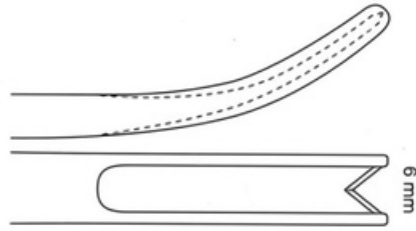

Item CodeDescription

27-O-29	BLUME GUARDED OSTEOTOME, 18CM, 6MM, CURVED, V SHAPED TIP
---------	--

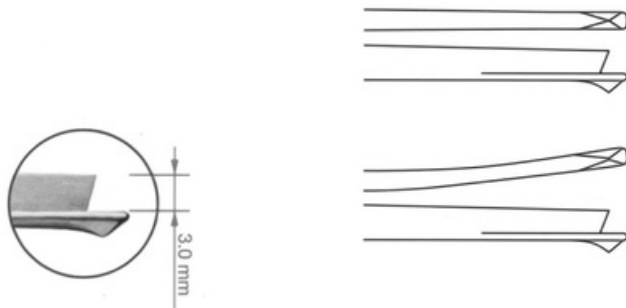

Item CodeDescription

27-O-30	SCHROM OSTEOTOME, 19.5CM, 3MM, STRAIGHT, WITH GUIDE THORN
27-O-31	SCHROM OSTEOTOME, 19.5CM, 3MM, RIGHT, WITH GUIDE THORN
27-O-32	SCHROM OSTEOTOME, 19.5CM, 3MM, LEFT, WITH GUIDE THORN

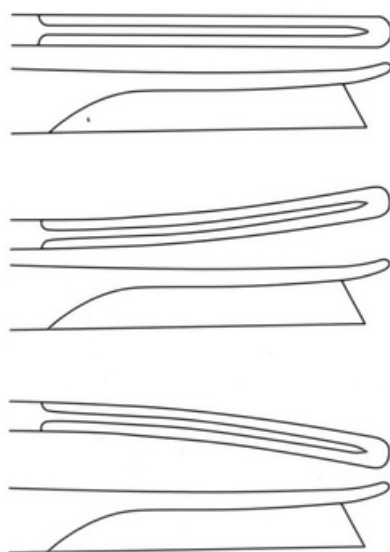

Item CodeDescription

27-O-33	SILVER OSTEOTOME, 18CM, STRAIGHT
27-O-34	SILVER OSTEOTOME, 18CM, CURVED LEFT
27-O-35	SILVER OSTEOTOME, 18CM, CURVED RIGHT

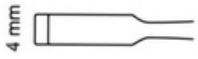

Item Code	Description
27-O-36	OBWEGESER OSTEOTOME, 15CM, 2.5MM
27-O-37	OBWEGESER OSTEOTOME, 15CM, 4.0MM



Item Code	Description
27-O-38	OBWEGESER SPLITTING OSTEOTOME, 21.5CM, 7MM
27-O-39	OBWEGESER SPLITTING OSTEOTOME, 21.5CM, 10MM

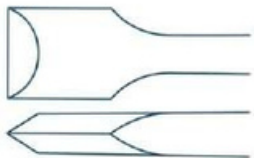

Item Code	Description
27-O-40	OBWEGESER WEDGE OSTEOTOME, 22CM, 8MM
27-O-41	OBWEGESER WEDGE OSTEOTOME, 22CM, 12MM
27-O-42	OBWEGESER WEDGE OSTEOTOME, 22CM, 16MM

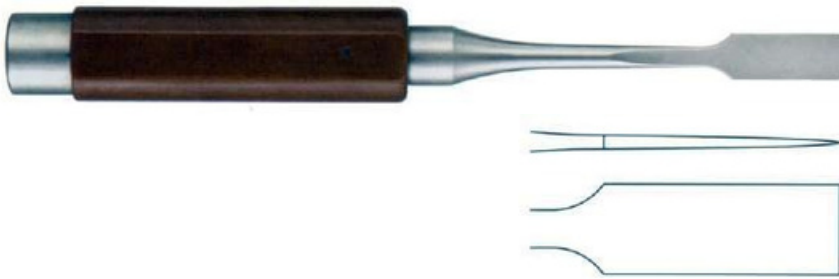

Item Code	Description
27-O-43	OBWEGESER BLADE OSTEOTOME, 22CM, 8MM
27-O-44	OBWEGESER BLADE OSTEOTOME, 22CM, 12MM
27-O-45	OBWEGESER BLADE OSTEOTOME, 22CM, 16MM
27-O-46	OBWEGESER BLADE OSTEOTOME, 22CM, 20MM

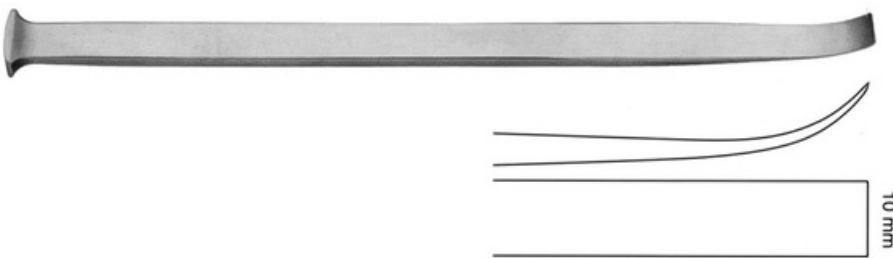

Item Code	Description
27-O-47	OBWEGESER PTERYGOID OSTEOTOME, 23.5CM, 10MM, CURVED

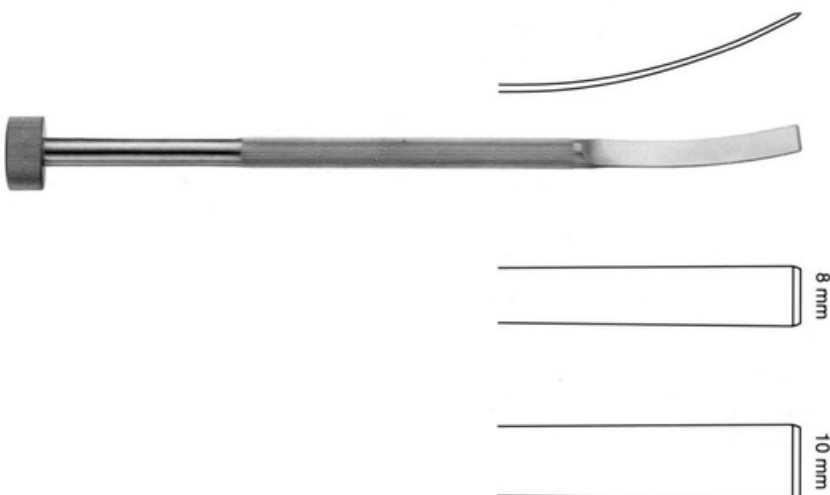

Item Code	Description
27-O-48	OBWEGESER FLEXIBLE OSTEOTOME, 21CM, 8MM, CURVED
27-O-49	OBWEGESER FLEXIBLE OSTEOTOME, 21CM, 10MM, CURVED

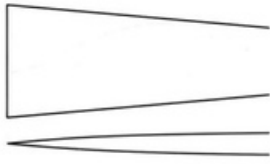

Item Code Description

27-O-51	TESSIER OSTEOTOME, 20.5CM, 10MM, STRAIGHT
27-O-52	TESSIER OSTEOTOME, 20.5CM, 10MM, CURVED
27-O-53	TESSIER OSTEOTOME, 20.5CM, 15MM, STRAIGHT
27-O-54	TESSIER OSTEOTOME, 20.5CM, 15MM, CURVED
27-O-55	TESSIER OSTEOTOME, 20.5CM, 20MM, STRAIGHT
27-O-56	TESSIER OSTEOTOME, 20.5CM, 30MM, STRAIGHT

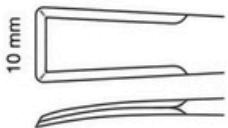
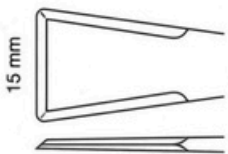
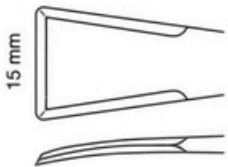

Item Code Description

27-O-57	TESSIER OSTEOTOME, 16CM, 10MM, STRAIGHT, BEVELED EDGES
27-O-58	TESSIER OSTEOTOME, 16CM, 10MM, CURVED, BEVELED EDGES
27-O-59	TESSIER OSTEOTOME, 16CM, 15MM, STRAIGHT, BEVELED EDGES
27-O-60	TESSIER OSTEOTOME, 16CM, 15MM, CURVED, BEVELED EDGES

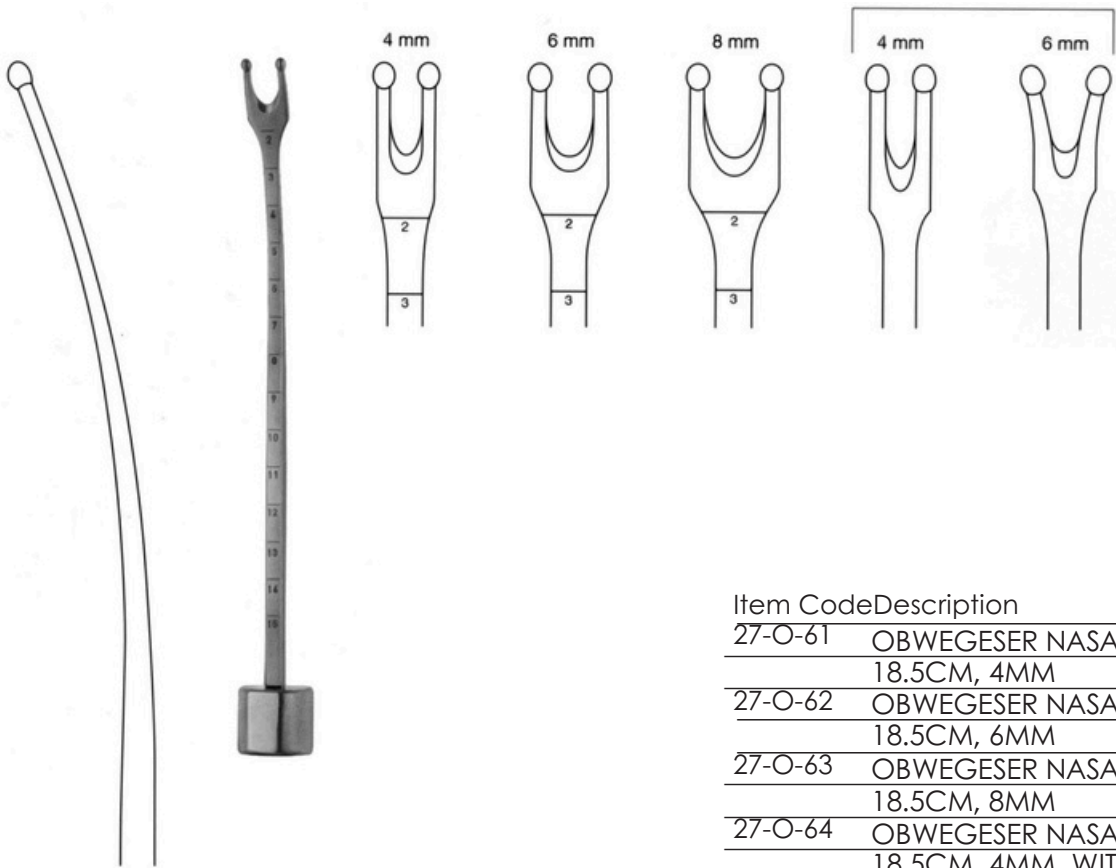

Item Code	Description
27-O-61	OBWEGESER NASAL SEPTUM OSTEOTOME, 18.5CM, 4MM
27-O-62	OBWEGESER NASAL SEPTUM OSTEOTOME, 18.5CM, 6MM
27-O-63	OBWEGESER NASAL SEPTUM OSTEOTOME, 18.5CM, 8MM
27-O-64	OBWEGESER NASAL SEPTUM OSTEOTOME, 18.5CM, 4MM, WITHOUT SCALE

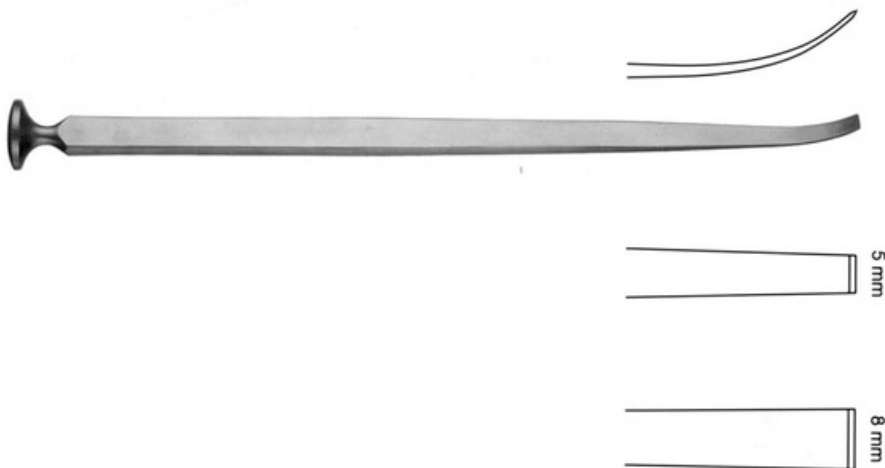

Item Code	Description
27-O-66	STEINHAUSER ORBITAL OSTEOTOME, 22.5CM, 5MM, CURVED
27-O-67	STEINHAUSER ORBITAL OSTEOTOME, 22.5CM, 8MM, CURVED



Item Code	Description
27-O-79	ROZNER NASAL OSTEOTOME, 6.5 MM WIDTH, 6 1/2" (165 MM) LENGTH



Item Code	Description
27-O-80	GIUNTA OSTEOTOME, DOUBLE GUARDED, CURVED, 4 MM WIDTH, 7" (178 MM) LENGTH



Item Code	Description
27-O-81	LAMBOTTE OSTEOTOME, 4 MM WIDTH, 5" (127 MM) LENGTH
27-O-82	LAMBOTTE OSTEOTOME, 6 MM WIDTH, 5" (127 MM) LENGTH
27-O-83	LAMBOTTE OSTEOTOME, 8 MM WIDTH, 5" (127 MM) LENGTH
27-O-84	LAMBOTTE OSTEOTOME, 10 MM WIDTH, 5" (127 MM) LENGTH
27-O-85	LAMBOTTE OSTEOTOME, 12 MM WIDTH, 5" (127 MM) LENGTH



Item Code	Description
28-R-01	FREER RASPATORY, 19CM, 5/5MM, DOUBLE ENDED, SHARP / SHARP

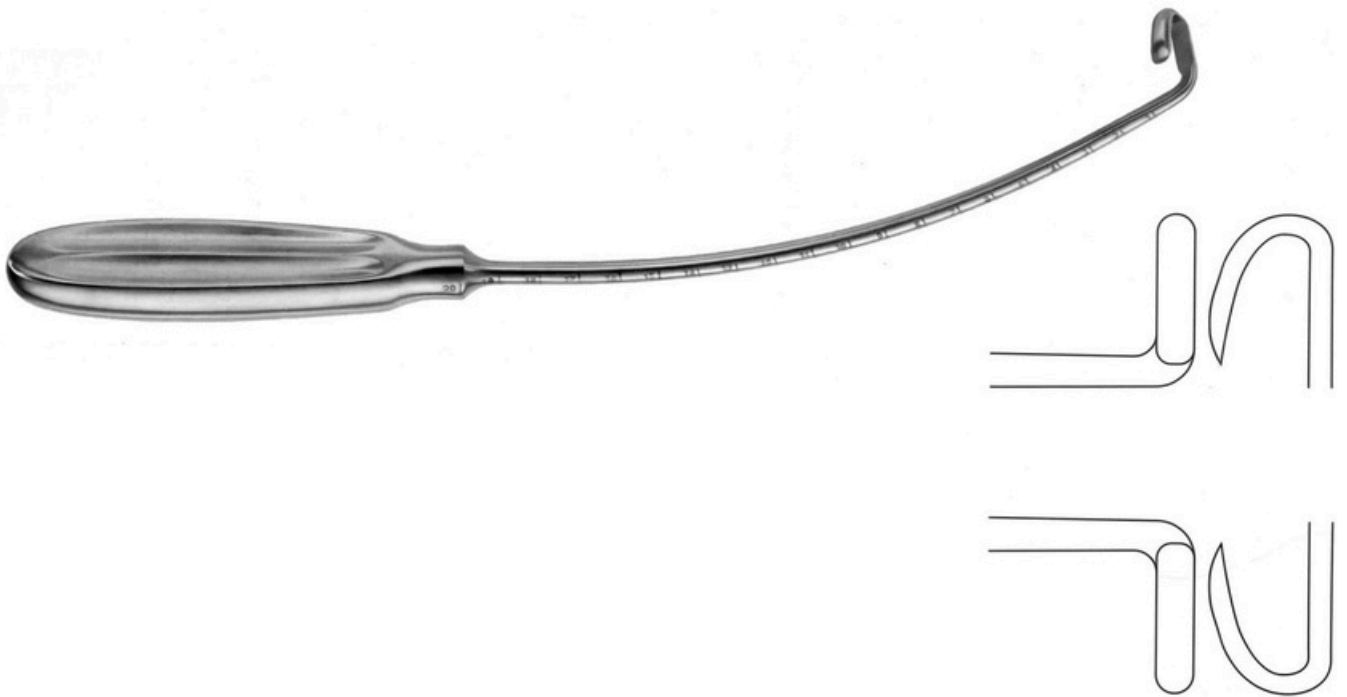

Item Code	Description
28-R-09	OBWEGESER RIB RASPATORY, 30CM, LEFT
28-R-10	OBWEGESER RIB RASPATORY, 30CM, RIGHT

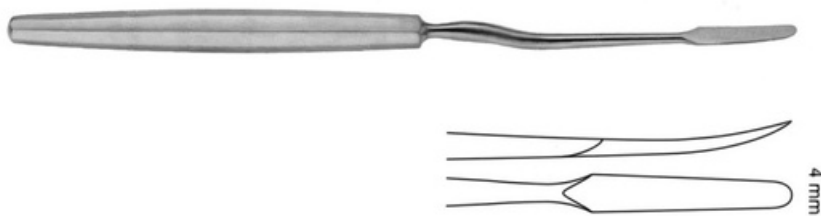

Item Code	Description
28-R-11	JOSEPH MASING SEPTUM RASPATORY, 22CM, 4MM, SHARP



Item Code	Description
28-R-12	COTTLE PERIOSTEAL ELEVATOR/RASPATORY, 18CM, 8MM, SHARP

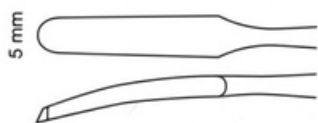

Item Code	Description
28-R-13	CONVERSE PERIOSTEAL ELEVATOR/ RASPATORY, 18CM, 5MM, SHARP

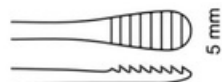
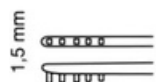

Item Code	Description
28-R-14	COTTLE PERIOSTEUM COMB AND RASPATORY, 23CM, 1.5/5MM, DOUBLE ENDED



Item Code	Description
28-R-15	COTTLE MCKENTY RASPATORY, 22CM, 4/4MM, DOUBLE ENDED, SHARP



Item Code	Description
28-R-16	OBWEGESER PERIOSTEAL ELEVATOR / RASPATORY, 17.5CM, 6MM, SHARP
28-R-17	OBWEGESER PERIOSTEAL ELEVATOR / RASPATORY, 17.5CM, 7MM, SHARP
28-R-18	OBWEGESER PERIOSTEAL ELEVATOR / RASPATORY, 17.5CM, 9MM, SHARP
28-R-19	OBWEGESER PERIOSTEAL ELEVATOR / RASPATORY, 17.5CM, 11MM, SHARP

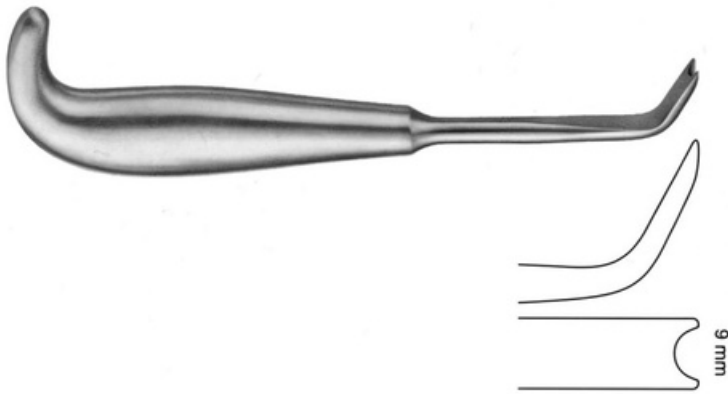

Item Code	Description
28-R-20	HARGIS RASPATORY, 19CM, 9MM, ANGLED

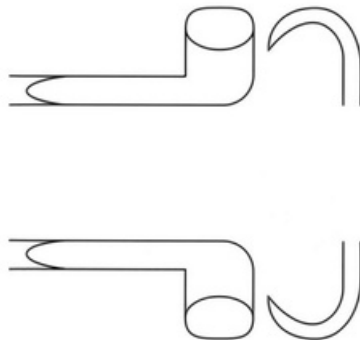

Item Code	Description
28-R-21	OBWEGESER MANDIBULAR RIM STRIPPER, 19CM



Item Code	Description
28-R-23	OBWEGESER PERIOSTEAL ELEVATOR / RASPATORY, 17.5CM, 9MM, V NOTCH

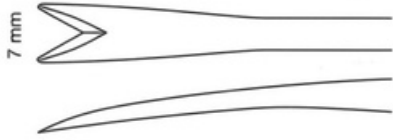
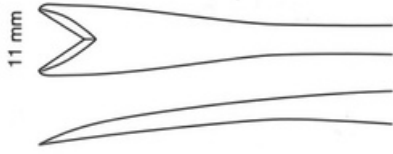

Item Code Description

28-R-24	OBWEGESER SWALLOWTAIL STRIPPER, 17.5CM, 7MM
28-R-25	OBWEGESER SWALLOWTAIL STRIPPER, 17.5CM, 11MM

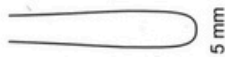
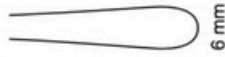
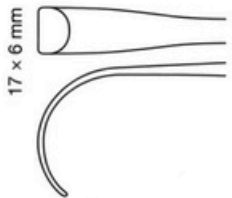
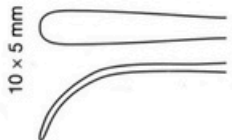

Item Code Description

28-R-29	OBWEGESER FREER PERIOSTEAL ELEVATOR, 21CM, SHARP / BLUNT
28-R-30	OBWEGESER FREER PERIOSTEAL ELEVATOR / RASPATORY, 21CM, 5MM SHARP / 10X5MM BLUNT
28-R-31	OBWEGESER FREER PERIOSTEAL ELEVATOR / RASPATORY, 21CM, 6MM SHARP / 13X6MM BLUNT

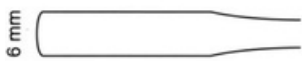

Item Code Description

28-R-32	OBWEGESER PERIOSTEAL ELEVATOR, 18CM, 6MM, BEVELED EDGE
28-R-33	OBWEGESER PERIOSTEAL ELEVATOR, 18CM, 7MM, BEVELED EDGE
28-R-34	OBWEGESER PERIOSTEAL ELEVATOR, 18CM, 9MM, BEVELED EDGE
28-R-35	OBWEGESER PERIOSTEAL ELEVATOR, 18CM, 11MM, BEVELED EDGE

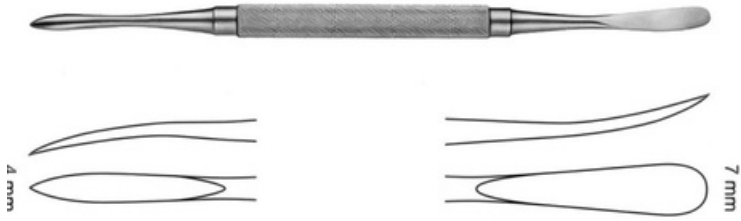

Item Code	Description
28-R-36	DINGMAN PERIOSTEAL ELEVATOR / RASPATORY, 18CM, 4/7MM, SHARP / BLUNT



Item Code	Description
28-R-37	TESSIER RASPATORY, 18CM, 8X6MM, 30 DEGREE CURVED
28-R-38	TESSIER RASPATORY, 18CM, 12X6MM, 60 DEGREE CURVED



Item Code	Description
28-R-39	STEINHAUSER ORBITAL FLOOR RASPATORY, 17CM, 9X4MM

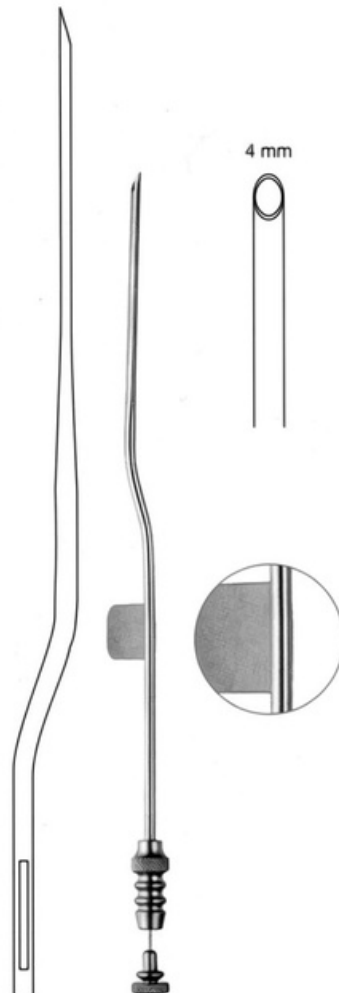

Item Code	Description
32-SR-01	SUCTION RASPATORY WITH GUIDE, 20CM, 4MM



Item Code	Description
34-WWI-01	OBWEGESER T.C. WIRE TWISTER, 13CM



Item Code	Description
34-WWI-02	OBWEGESER WIRE LOOP CLIP, 15.5CM

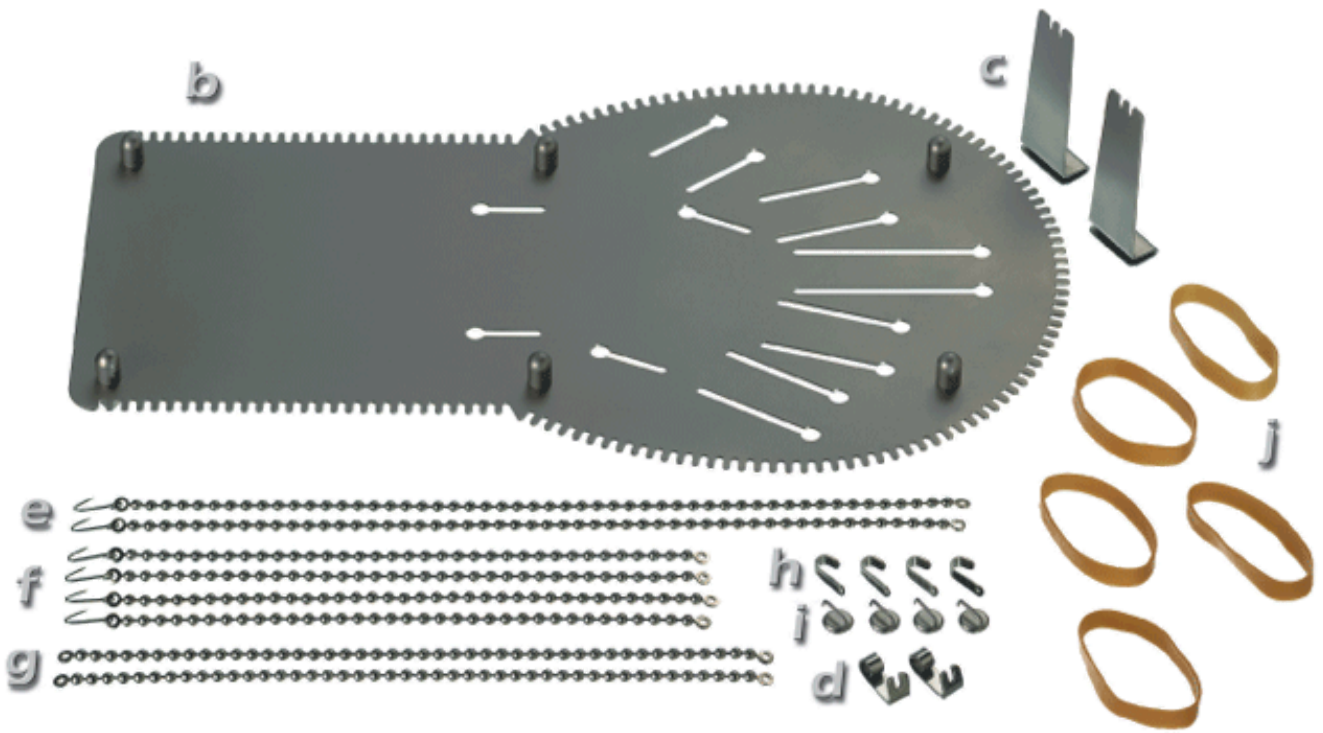

Item Code	Description
SU-I-01-01	Tuppers Hand Retractor Set, Medium
SU-I-01-02	Tuppers Hand Retractor Set, For Infants
SU-I-01-03	Tuppers Hand Retractor Set, For Adults



Item Code	Description
DDT-01-01	TISSUE FORCEPS, 14.5CM, 1X2 TEETH



Item Code	Description
DDT-01-02	HUDSON EWALD DRESSING FORCEPS, 12CM, SERRATED



Item Code	Description
DDT-01-03	HUDSON EWALD TISSUE FORCEPS, 12CM, 1X2 TEETH



Item Code	Description
DDT-01-04	ADSON FORCEPS, 12CM, SERRATED
DDT-01-07	ADSON FORCEPS, 12CM, 1X2 TEETH



Item Code	Description
DDT-01-05	ADSON T.C.(TUNGSTEN CARBIDE) TISSUE FORCEPS, 12CM



Item Code	Description
DDT-01-06	ADSON T.C.(TUNGSTEN CARBIDE) TISSUE FORCEPS, 15CM



Item Code	Description
DDT-01-08	ADSON TISSUE FORCEPS, 12CM, CROSS SERRATED



Item Code	Description
DDT-01-09	ADSON DELICATE TISSUE AND SUTURE FORCEPS, 15CM, 1X2 TEETH



Item Code	Description
DDT-01-10	ADSON T.C. (TUNGSTEN CARBIDE) DELICATE TISSUE AND SUTURE FORCEPS, 12CM, 1X2 TEETH



Item Code	Description
DDT-01-11	ADSON T.C. (TUNGSTEN CARBIDE) TISSUE AND SUTURE FORCEPS, 15CM, 1X2 TEETH



Item Code	Description
DDT-01-12	MICRO ADSON FORCEPS, 12CM, SERRATED
DDT-01-14	MICRO ADSON FORCEPS, 12CM, 1X2 TEETH
DDT-01-13	MICRO ADSON FORCEPS, 15CM, SERRATED
DDT-01-15	MICRO ADSON FORCEPS, 15CM, 1X2 TEETH



Item Code	Description
DDT-01-16	ADSON BROWN DELICATE TISSUE FORCEPS, 12CM, 7X7 TEETH, STRAIGHT
DDT-01-17	ADSON BROWN DELICATE TISSUE FORCEPS, 12CM, 9X9 TEETH, STRAIGHT



Item Code	Description
DDT-01-18	ADSON BROWN DELICATE TISSUE FORCEPS, 12CM, 7X7 TEETH, ANGLED



Item Code	Description
DDT-01-19	ADSON GRAEFE DELICATE TISSUE FORCEPS, 12CM



Item Code	Description
DDT-01-20	SEMKEN DELICATE DRESSING AND TISSUE FORCEPS, 12.5CM, STRAIGHT
DDT-01-22	SEMKEN DELICATE DRESSING FORCEPS, 12.5CM, CURVED
DDT-01-21	SEMKEN DELICATE DRESSING FORCEPS, 15CM, STRAIGHT
DDT-01-23	SEMKEN DELICATE DRESSING FORCEPS, 15CM, CURVED



Item Code	Description
DDT-01-24	SEMKEN DELICATE TISSUE FORCEPS, 12.5CM, 1X2 TEETH, STRAIGHT
DDT-01-26	SEMKEN DELICATE TISSUE FORCEPS, 12.5CM, 1X2 TEETH, CURVED
DDT-01-25	SEMKEN DELICATE TISSUE FORCEPS, 15CM, 1X2 TEETH, STRAIGHT
DDT-01-27	SEMKEN DELICATE TISSUE FORCEPS, 15CM, 1X2 TEETH, CURVED



Item Code	Description
DDT-01-28	SEMKEN DELICATE TISSUE FORCEPS, 12.5CM, 2X3 TEETH, STRAIGHT



Item Code	Description
DDT-01-29	MCINDOE DRESSING FORCEPS, 15CM, SERRATED



Item Code	Description
DDT-01-30	GILLIES TISSUE FORCEPS, 15CM, 1X2 TEETH



Item Code	Description
DT-02-01	WAUGH DRESSING FORCEPS, 15CM, SERRATED
DT-02-03	WAUGH TISSUE FORCEPS, 15CM, 1X2 TEETH



Item Code	Description
DT-02-02	WAUGH DRESSING FORCEPS, 20CM, SERRATED
DT-02-04	WAUGH TISSUE FORCEPS, 20CM, 1X2 TEETH



Item Code	Description
DT-02-06	GRUENWALD JANSEN NASAL BAYONET FORCEPS, 16CM, SERRATED



Item Code	Description
HF-03-01	DIETRICH BULLDOG CLAMP, 4.5CM, STRAIGHT JAW, 8MM
HF-03-02	DIETRICH BULLDOG CLAMP, 5CM, STRAIGHT JAW, 12MM
HF-03-03	DIETRICH BULLDOG CLAMP, 5.5CM, STRAIGHT JAW, 16MM

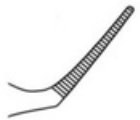

Item Code	Description
HF-03-04	DIETRICH BULLDOG CLAMP, 4.5CM, CURVED JAW, 8MM
HF-03-05	DIETRICH BULLDOG CLAMP, 5CM, CURVED JAW, 12MM
HF-03-06	DIETRICH BULLDOG CLAMP, 5.5CM, CURVED JAW, 16MM



Item Code	Description
HF-03-19	ATRAUMATIC MOSQUITO FORCEPS, 12CM, STRAIGHT
HF-03-24	ATRAUMATIC MOSQUITO FORCEPS, 12CM, CURVED



Item Code	Description
HF-03-07	HALSTED MICRO MOSQUITO FORCEPS, 12.5CM, STRAIGHT



HF-03-08	HALSTED MICRO MOSQUITO FORCEPS, 12.5CM, CURVED
----------	--

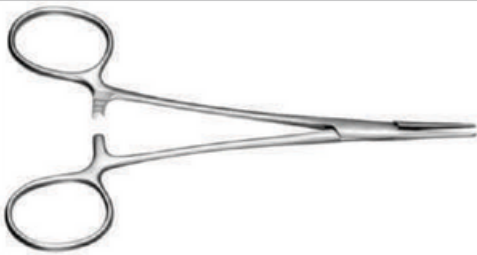

Item Code	Description
HF-03-13	HALSTED MICRO MOSQUITO FORCEPS, 12.5CM, 1X2 TEETH, STRAIGHT



HF-03-14	HALSTED MICRO MOSQUITO FORCEPS, 12.5CM, 1X2 TEETH, CURVED
----------	---



Item Code	Description
HF-03-09	JACOBSON MICRO MOSQUITO FORCEPS, 12.5CM, STRAIGHT



HF-03-10	JACOBSON MICRO MOSQUITO FORCEPS, 12.5CM, CURVED
----------	---

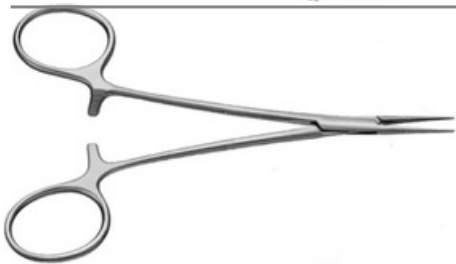

Item Code	Description
HF-03-11	JACOBSON KOSHIMA MICRO MOSQUITO FORCEPS, 12.5CM, STRAIGHT



HF-03-12	JACOBSON KOSHIMA MICRO MOSQUITO FORCEPS, 12.5CM, CURVED
----------	---



Item Code Description

HF-03-15 ULTRA DELICATE ARTERY FORCEPS,
10CM, STRAIGHT

HF-03-20 ULTRA DELICATE ARTERY FORCEPS,
10CM, CURVED

HF-03-17 ULTRA DELICATE ARTERY FORCEPS,
2.5CM, STRAIGHT

HF-03-22 ULTRA DELICATE ARTERY FORCEPS,
12.5CM, CURVED

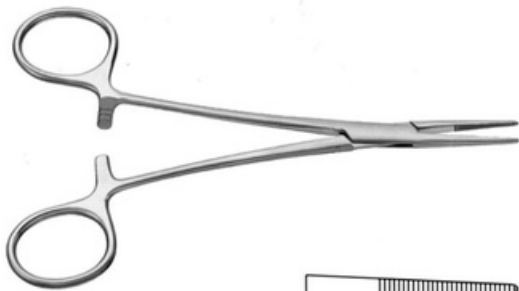

Item Code Description

HF-03-29 PROVIDENCE HOSPITAL ARTERY FORCEPS,
14CM, STRAIGHT

HF-03-30 PROVIDENCE HOSPITAL ARTERY FORCEPS,
14CM, CURVED

HF-03-31 PROVIDENCE HOSPITAL ARTERY FORCEPS,
14CM, 1X2 TEETH, STRAIGHT

HF-03-32 PROVIDENCE HOSPITAL ARTERY FORCEPS,
14CM, 1X2 TEETH, CURVED

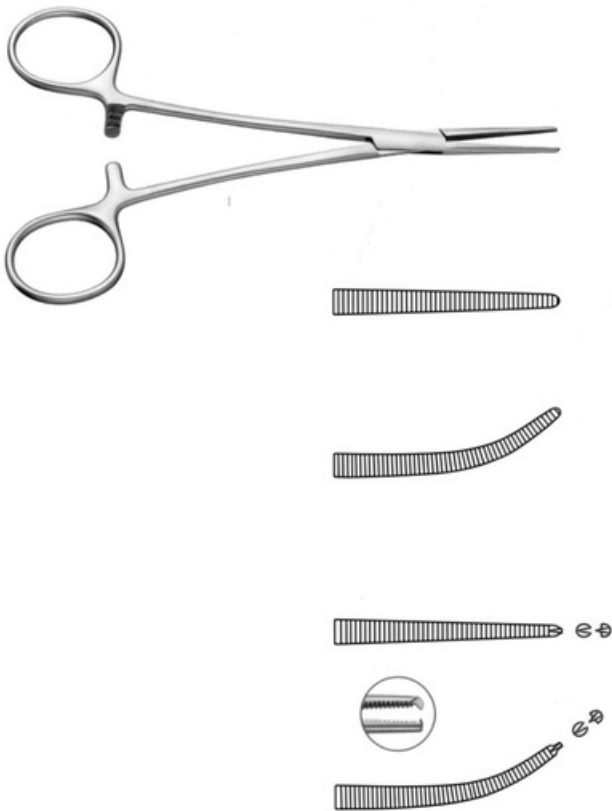

Item Code	Description
HF-03-33	LERICHE ARTERY FORCEPS, 15CM, STRAIGHT
HF-03-34	LERICHE ARTERY FORCEPS, 15CM, CURVED
HF-03-35	LERICHE ARTERY FORCEPS, 15CM, 1X2 TEETH, STRAIGHT
HF-03-36	LERICHE ARTERY FORCEPS, 15CM, 1X2 TEETH, CURVED



Item Code	Description
MF-04-01-01	Jewelers Forceps, Tapered Fine Points, 11.5cm, No. 3
MF-04-01-02	Jewelers Forceps, Tapered Fine Points, 11.5cm, No. 4
MF-04-01-03	Jewelers Forceps, Tapered Fine Points, 11.5cm, No. 5
MF-04-01-04	Jewelers Forceps, Tapered Fine Points, 11.5cm, No. 7

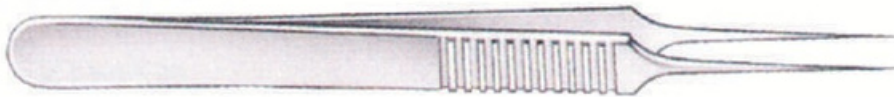

Item Code	Description
MF-04-02	Ultra Fine Micro Forceps, 11 cm, 0.1mm tips



Item Code	Description
MF-04-03-01	Micro Forceps, 11.5cm, 1x2 Teeth, Straight
MF-04-03-02	Micro Forceps, 11.5cm, 1x2 Teeth, Curved



Item Code	Description
MF-04-04-01	Micro Forceps, Straight, Sharp, 10.5cm, 0.2mm Tip
MF-04-04-02	Micro Forceps, Straight, Sharp, 10.5cm, 0.3mm Tip



Item Code	Description
MF-04-05-01	Micro Forceps, Curved, 11.5cm, Sharp, 0.2mm Tip
MF-04-05-02	Micro Forceps, Curved, 11.5cm, Sharp, 0.3mm Tip



Item Code	Description
MF-04-06-01	Micro Forceps, 45 Degree Angle, Sharp, 10.5cm, 0.2mm Tip
MF-04-06-02	Micro Forceps, 45 Degree Angle, Sharp, 10.5cm, 0.3mm Tip



Item Code	Description
MF-04-07-01	Ultra Fine Micro Forceps, Sharp, 14cm, 0.1mm Tip
MF-04-07-02	Ultra Fine Micro Forceps, Sharp, 14cm, 0.2mm Tip
MF-04-07-03	Ultra Fine Micro Forceps, Sharp, 14cm, 0.3mm Tip



Item Code	Description
MF-04-08-01	Micro Forceps, Round Handle, 12cm, Sharp, Straight
MF-04-08-02	Micro Forceps, Round Handle, 12cm, Sharp, Curved

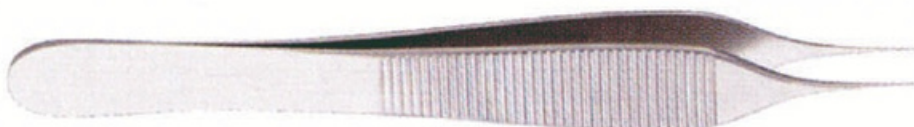

Item Code	Description
MF-04-09-01	Ultra Fine Adson Forceps, 12cm, 0.1mm Tip
MF-04-09-02	Ultra Fine Adson Forceps, 12cm, 0.2mm Tip



Item Code	Description
MF-04-10	Micro Adson Forceps, 15 cm, 0.3 mm, Sharp



Item Code	Description
TGF-06-01	DEBAKEY ATRAUMATIC VASCULAR FORCEPS, 15CM



Item Code	Description	NELSON	TISSUE
TGF-06-02	FORCEPS, 15CM	NELSON	TISSUE
TGF-06-03	FORCEPS, 23CM		



Item Code	Description
TGF-06-04	BAYONET GRASPING FORCEPS, 16CM



Item Code	Description
TGF-06-06	TROELTSCH WILDE ANGULAR FORCEPS, 13CM, ADULT

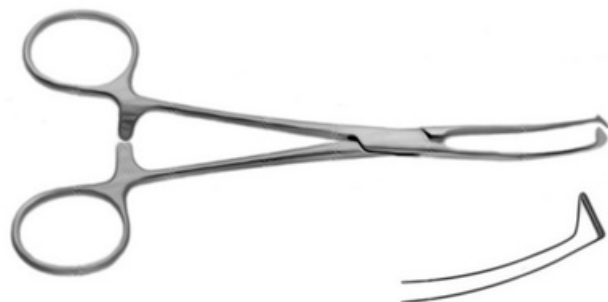

Item Code	Description
TGF-06-12	FOX TISSUE GRASPING FORCEPS, 15.5CM

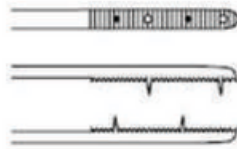

Item Code	Description
TGF-06-13	COTTLE NASAL FORCEPS, 15CM



Item Code	Description
TGF-06-08	COTTLE FIXATION FORCEPS, 15CM



Item Code	Description
TGF-06-09	FOX TISSUE FORCEPS, 13CM, CURVED
TGF-06-10	FOX TISSUE FORCEPS, 15CM, CURVED



Item Code	Description
TGF-06-11	FOX TISSUE FORCEPS, 15CM, WITH CATCH



Item Code	Description
ND-07-01	COLLIER NEEDLE HOLDER, 13CM

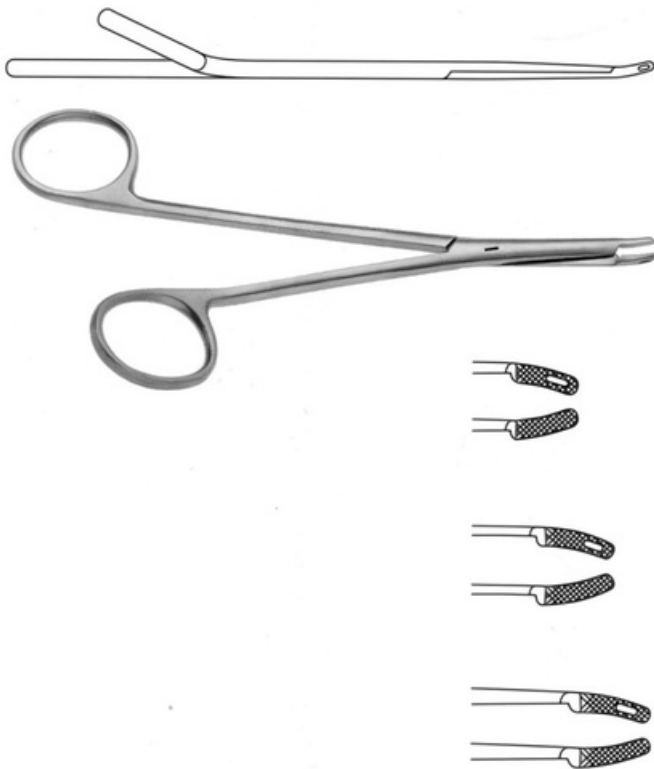

Item Code	Description
ND-07-02	OBWEGESER GILLIES NEEDLE HOLDER WITH SCISSORS, 11.5CM
ND-07-04	OBWEGESER GILLIES NEEDLE HOLDER WITH SCISSORS, 14.5CM
ND-07-06	OBWEGESER GILLIES NEEDLE HOLDER WITH SCISSORS, 17CM

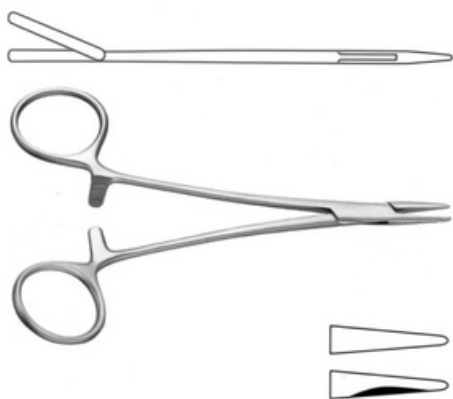

Item Code	Description
ND-07-03	NEIVERT NEEDLE HOLDER, 12.5CM

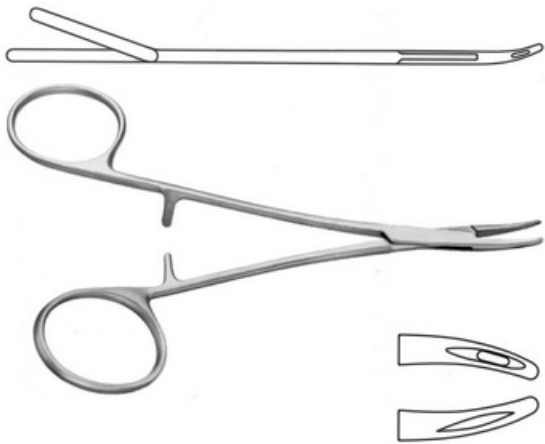

Item Code	Description
ND-07-05	CONVERSE NEEDLE HOLDER, 15CM

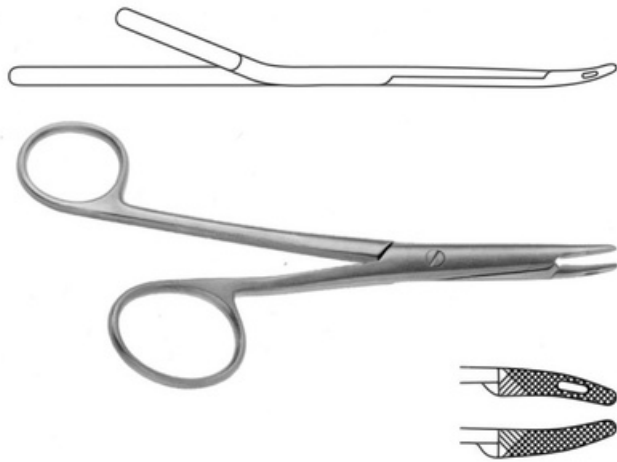

Item Code	Description
ND-07-07	OBWEGESER GILLIES NEEDLE HOLDER WITH SCISSORS, 16CM, HEAVY MODEL



Item Code	Description
ND-07-08	NEIVERT T.C. NEEDLE HOLDER, 12.5CM, SMOOTH

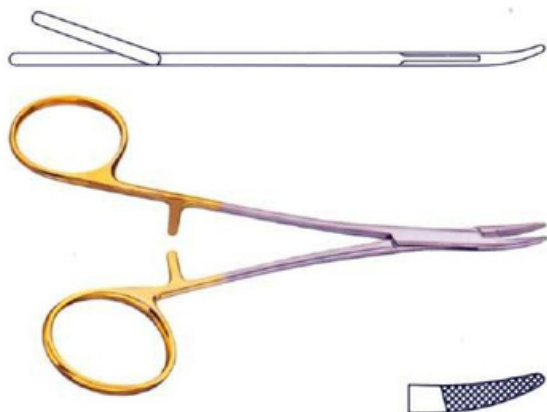

Item Code	Description
ND-07-09	CONVERSE T.C. NEEDLE HOLDER, 15CM



Item CodeDescription

ND-07-10 NAGATA T.C. NEEDLE HOLDER, 11.5CM

ND-07-11 NAGATA T.C. NEEDLE HOLDER, 13CM



Item CodeDescription

ND-07-12 WRIGHT DERF NEEDLE HOLDER, 12.5CM



Item CodeDescription

ND-07-13 HALSEY NEEDLE HOLDER, 13.5CM,
SERRATED



Item CodeDescription

ND-07-14 GUBISCH T.C. NEEDLE HOLDER, 12.5CM,
EXTRA FINE



Item Code	Description
ND-07-15	WRIGHT DERF T.C. NEEDLE HOLDER, 12.5CM, SERRATED

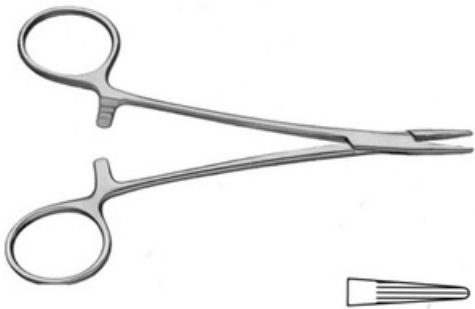

Item Code	Description
ND-07-17	DERF CONVERSE NEEDLE HOLDER, 12.5CM

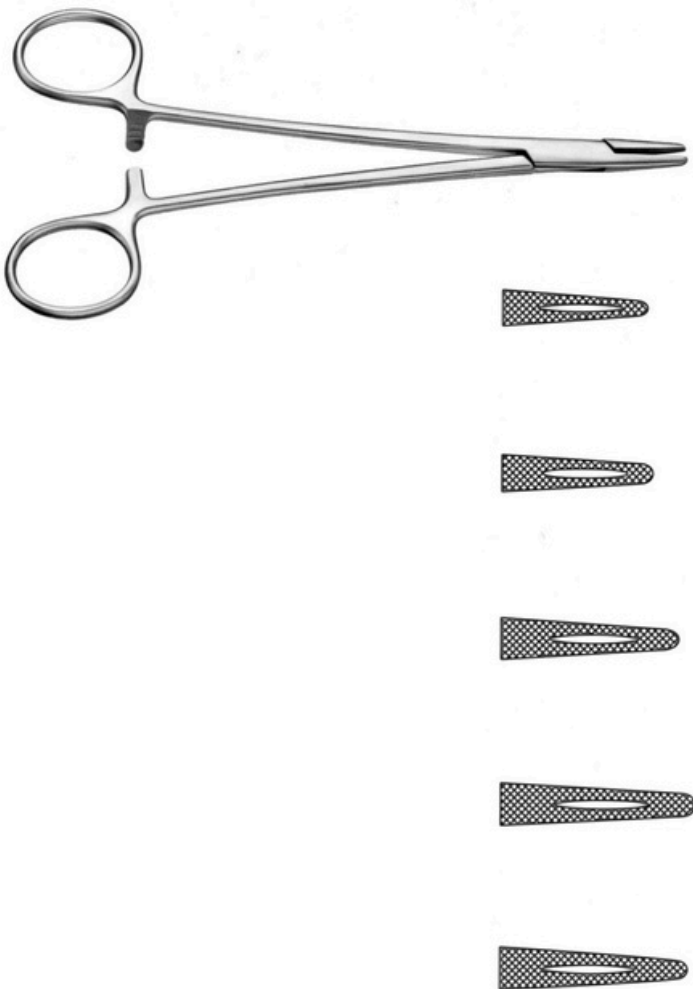

Item Code	Description
ND-07-18	MAYO HEGAR NEEDLE HOLDER, 15CM
ND-07-19	MAYO HEGAR NEEDLE HOLDER, 18CM
ND-07-20	MAYO HEGAR NEEDLE HOLDER, 20CM
ND-07-21	MAYO HEGAR NEEDLE HOLDER, 23CM
ND-07-22	MAYO HEGAR NEEDLE HOLDER, 24CM

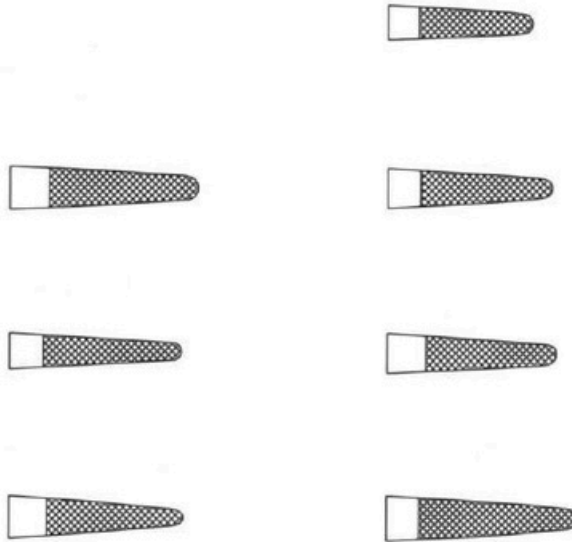
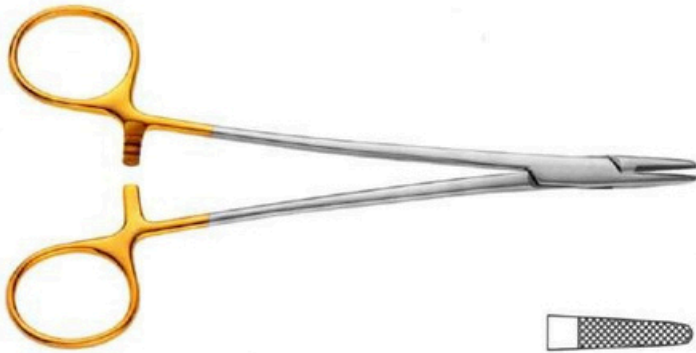

Item CodeDescription

ND-07-23	MAYO HEGAR T.C. NEEDLE HOLDER, 15CM
ND-07-24	MAYO HEGAR T.C. NEEDLE HOLDER, 18CM
ND-07-25	MAYO HEGAR T.C. NEEDLE HOLDER, 20CM
ND-07-26	MAYO HEGAR T.C. NEEDLE HOLDER, 23CM
ND-07-27	MAYO HEGAR T.C. NEEDLE HOLDER, 24CM
ND-07-28	MAYO HEGAR T.C. NEEDLE HOLDER, 26CM
ND-07-29	MAYO HEGAR T.C. NEEDLE HOLDER, 30CM

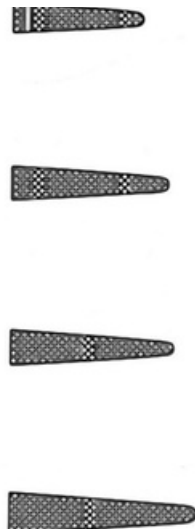

Item CodeDescription

ND-07-34	CRILE WOOD NEEDLE HOLDER, 15CM
ND-07-35	CRILE WOOD NEEDLE HOLDER, 18CM
ND-07-36	CRILE WOOD NEEDLE HOLDER, 20CM
ND-07-37	CRILE WOOD NEEDLE HOLDER, 23CM

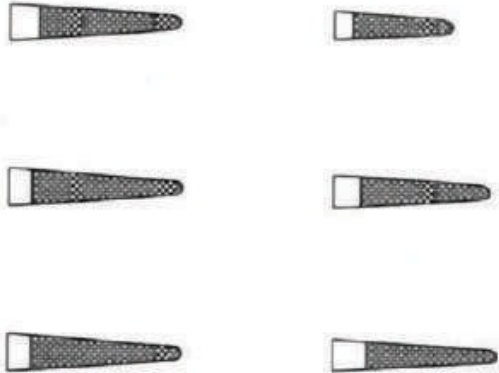

Item Code Description

ND-07-38	CRILE WOOD T.C. NEEDLE HOLDER, 15CM
ND-07-39	CRILE WOOD T.C. NEEDLE HOLDER, 18CM
ND-07-40	CRILE WOOD T.C. NEEDLE HOLDER, 20CM
ND-07-41	CRILE WOOD T.C. NEEDLE HOLDER, 23CM
ND-07-42	CRILE WOOD T.C. NEEDLE HOLDER, 25CM
ND-07-43	CRILE WOOD T.C. NEEDLE HOLDER, 30CM

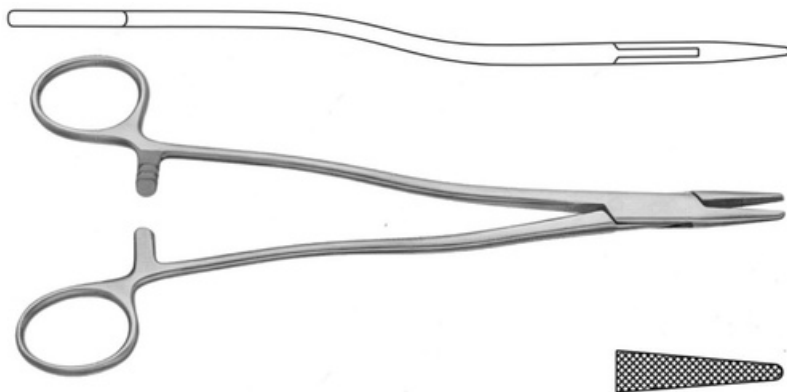

Item Code Description

ND-07-44	THOMSON WALKER BOZEMANN NEEDLE HOLDER, 21CM, S SHAPE
----------	--

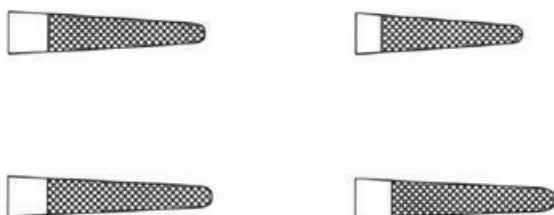
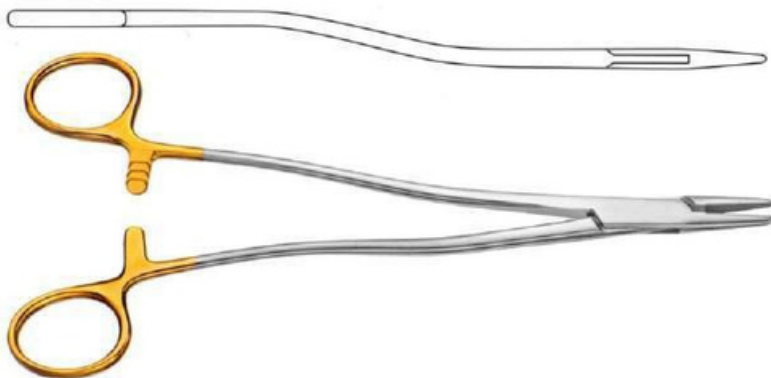

Item Code Description

ND-07-45	BOZEMANN WERTHEIM T.C. NEEDLE HOLDER, 21CM, S SHAPE
ND-07-46	BOZEMANN WERTHEIM T.C. NEEDLE HOLDER, 24CM, S SHAPE
ND-07-47	BOZEMANN WERTHEIM T.C. NEEDLE HOLDER, 26CM, S SHAPE
ND-07-48	BOZEMANN WERTHEIM T.C. NEEDLE HOLDER, 30CM, S SHAPE

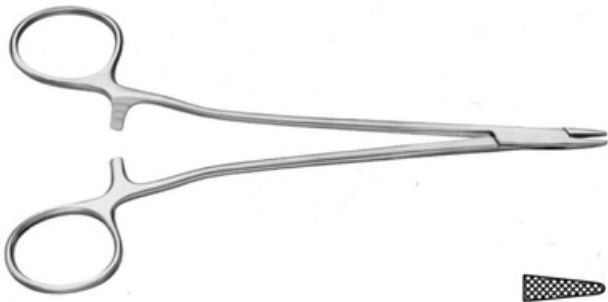

Item Code	Description
ND-07-49	SENNING NEEDLE HOLDER, 17CM, EXTRA DELICATE PATTERN

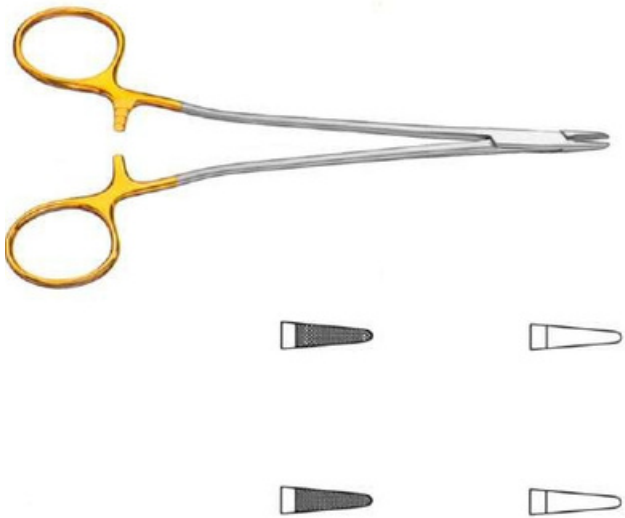

Item Code	Description
ND-07-50	SENNING T.C. NEEDLE HOLDER, 15CM, SMOOTH
ND-07-52	SENNING T.C. NEEDLE HOLDER, 15CM, SERRATED
ND-07-51	SENNING T.C. NEEDLE HOLDER, 17CM, SMOOTH
ND-07-53	SENNING T.C. NEEDLE HOLDER, 17CM, SERRATED

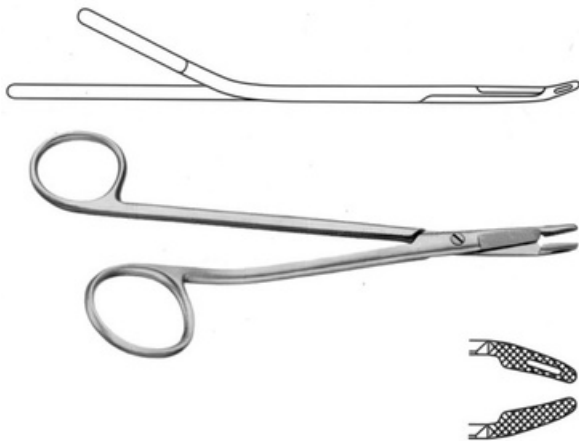

Item Code	Description
ND-07-54	GILLIES SLIM NEEDLE HOLDER WITH SCISSORS, 14.5CM
ND-07-55	GILLIES NEEDLE HOLDER WITH SCISSORS, 15CM

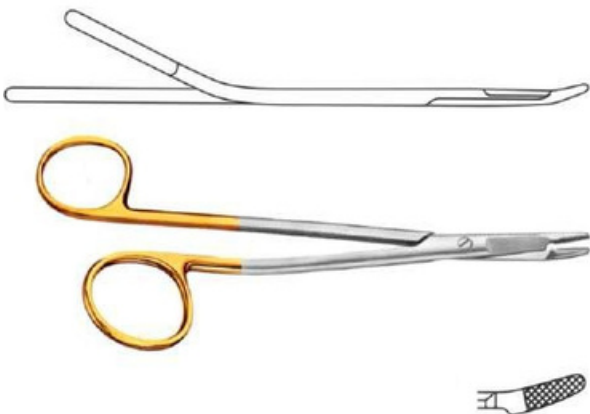

Item Code	Description
ND-07-56	GILLIES SLIM T.C. NEEDLE HOLDER WITH SCISSORS, 14.5CM
ND-07-57	GILLIES T.C. NEEDLE HOLDER WITH SCISSORS, 15CM



Item Code	Description
ND-07-58	MATHIEU T.C. NEEDLE HOLDER, 14CM
ND-07-59	MATHIEU T.C. NEEDLE HOLDER, 17CM
ND-07-60	MATHIEU T.C. NEEDLE HOLDER, 20CM
ND-07-61	MATHIEU T.C. NEEDLE HOLDER, 24CM



a = 60 mm



a = 90 mm



smooth jaws

Item Code	Description
ND-07-62	COTTLE MASING NEEDLE HOLDER, SMOOTH JAWS, DELICATE, 6CM SHAFT
ND-07-63	COTTLE MASING NEEDLE HOLDER, SMOOTH JAWS, DELICATE, 9CM SHAFT



Item Code	Description
ND-07-64	Corwin Hegar T.C. Wire Twisting Forceps, 16cm

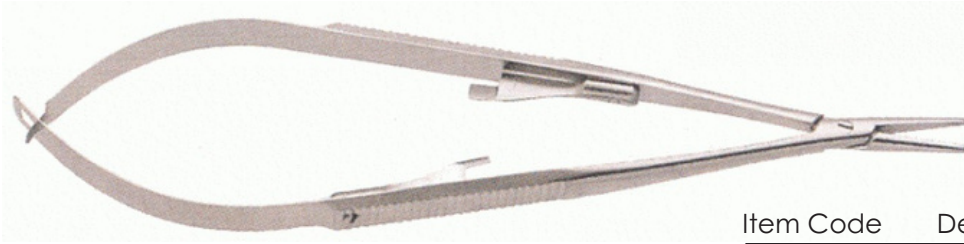

Item Code	Description
MNH-08-01-01	Castroviejo Needle Holder, Standard, With Catch, 14cm, Straight
MNH-08-01-02	Castroviejo Needle Holder, Standard, With Catch, 14cm, Curved
MNH-08-01-03	Castroviejo Needle Holder, Standard, With Catch, 17cm, Straight
MNH-08-01-04	Castroviejo Needle Holder, Standard, With Catch, 17cm, Curved

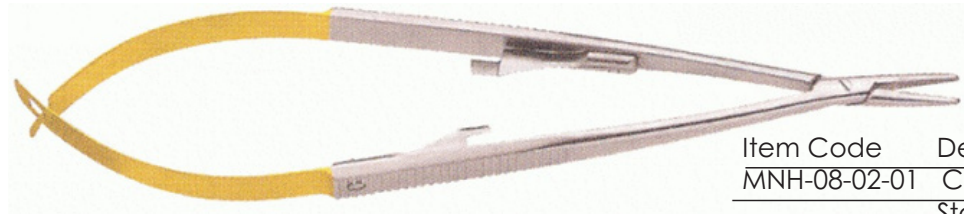

Item Code	Description
MNH-08-02-01	Castroviejo Needle Holder, T.C, Standard, With catch, 14cm, Plain
MNH-08-02-02	Castroviejo Needle Holder, T.C, Standard, With catch, 14cm, Serrated
MNH-08-02-03	Castroviejo Needle Holder, T.C, Standard, With catch, 17cm, Plain
MNH-08-02-04	Castroviejo Needle Holder, T.C, Standard, With catch, 17cm, Serrated



Item Code	Description
MNH-08-03-01	Castroviejo Ultra Fine Needle Holder, 14.5 cm, With Catch, Straight
MNH-08-03-02	Castroviejo Ultra Fine Needle Holder, 14.5 cm, With Catch, Curved

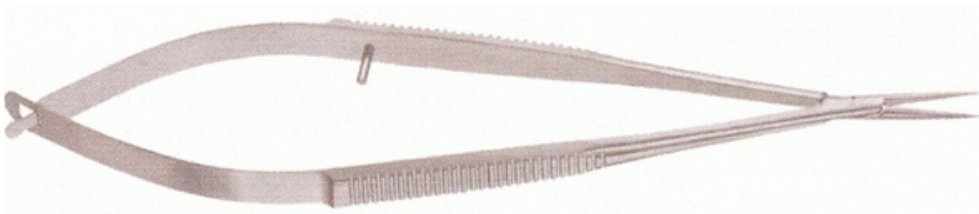

Item Code	Description
MNH-08-04-01	Castroviejo Ultra Fine Needle Holder, 14.5 cm, Without Catch, Straight
MNH-08-04-02	Castroviejo Ultra Fine Needle Holder, 14.5 cm, Without Catch, Curved

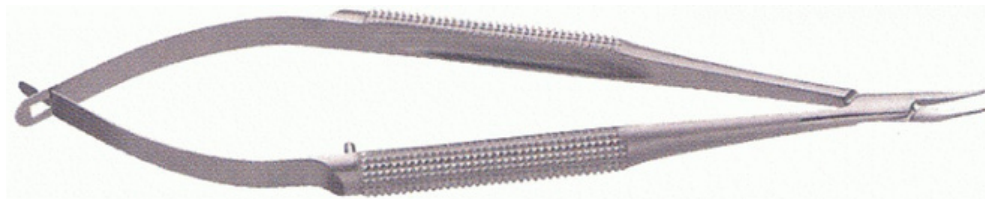

Item Code	Description
MNH-08-05-01	Barraquer Needle Holder, Round Handle, Without Catch, 11.5cm, Straight
MNH-08-05-02	Barraquer Needle Holder, Round Handle, Without Catch, 11.5cm, Curved
MNH-08-05-03	Barraquer Needle Holder, Round Handle, Without Catch, 14cm, Straight
MNH-08-05-04	Barraquer Needle Holder, Round Handle, Without Catch, 14cm, Curved

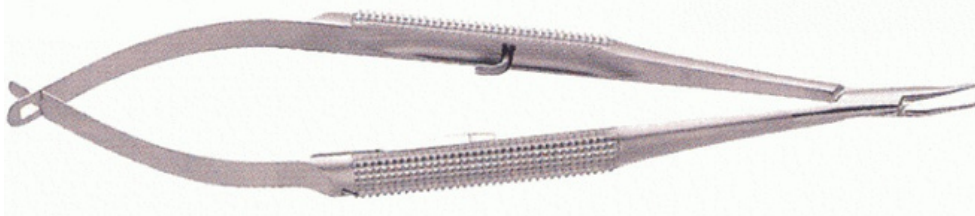

Item Code	Description
MNH-08-06-01	Barraquer Needle Holder, Round Handle, With Catch, 11.5cm, Straight
MNH-08-06-02	Barraquer Needle Holder, Round Handle, With Catch, 11.5cm, Curved
MNH-08-06-03	Barraquer Needle Holder, Round Handle, With Catch, 14cm, Straight
MNH-08-06-04	Barraquer Needle Holder, Round Handle, With Catch, 14cm, Curved

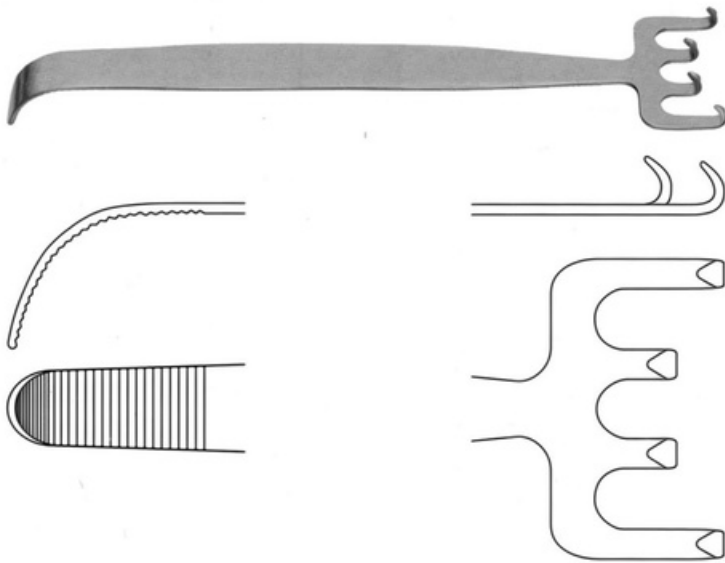

Item Code	Description
R-09-03	WALTER RETRACTOR, 19CM, 4 PRONGS

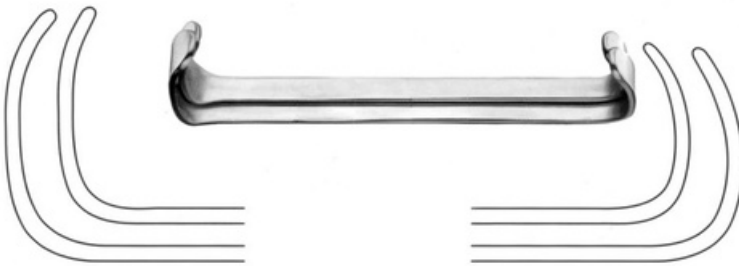

Item Code	Description
R-09-01	FARABEUFBABY RETRACTORS, 12CM, DOUBLE ENDED, SET OF 2

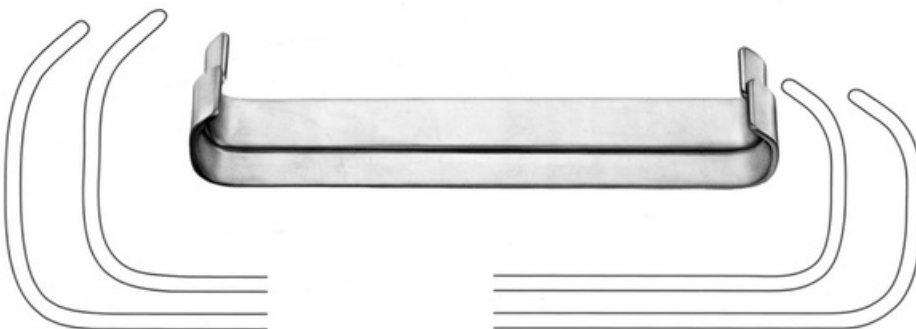

Item Code	Description
R-09-02	FARABEUFBABY RETRACTORS, 15CM, DOUBLE ENDED, SET OF 2

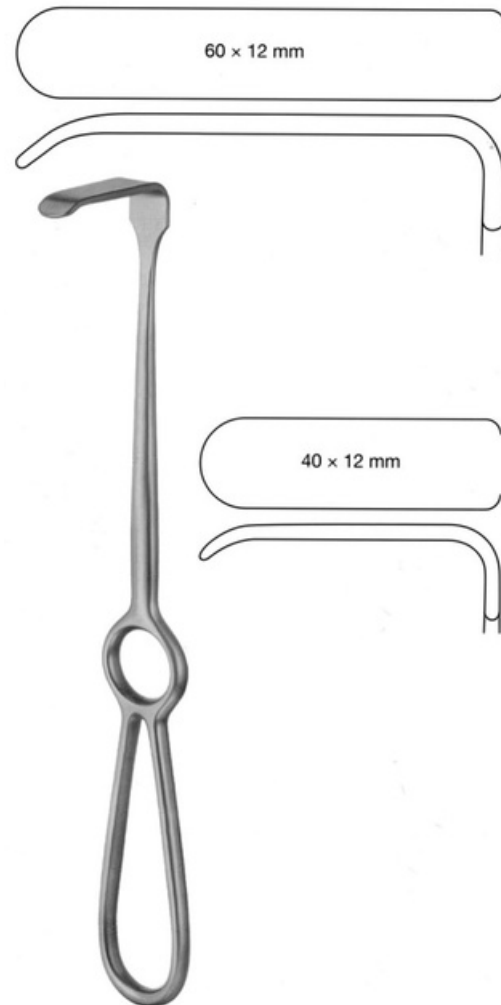
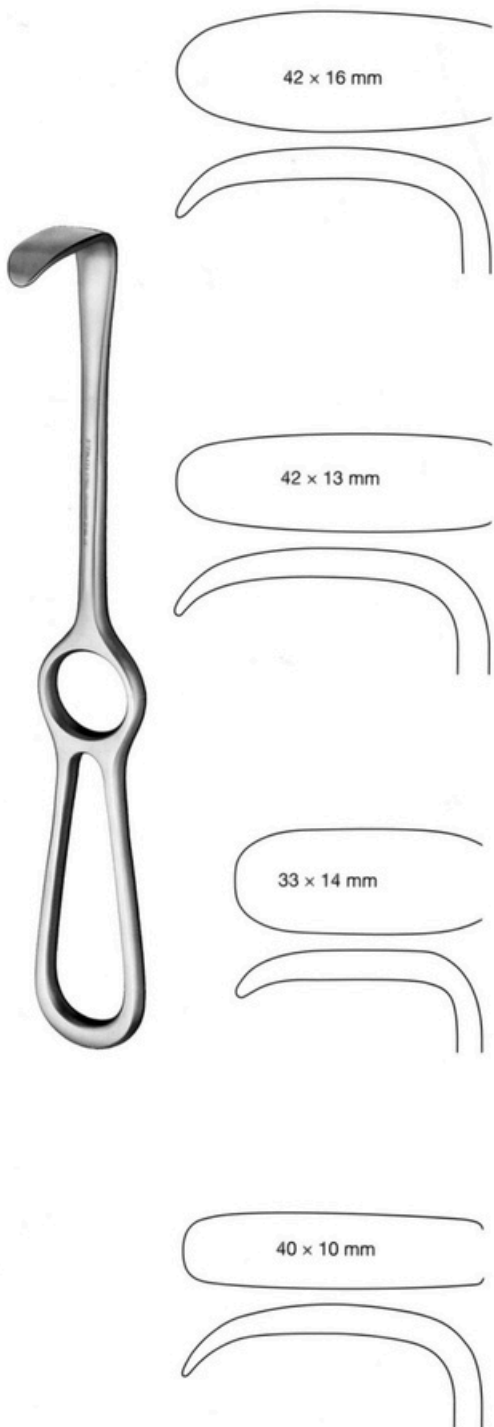

Item Code	Description
R-09-08	KOCHER RETRACTOR #1, 12MM WIDE X 40MM DEEP, 21CM
R-09-09	KOCHER RETRACTOR #2, 12MM WIDE X 60MM DEEP, 21CM

Item Code	Description
R-09-04	LANGENBECK RETRACTOR, 10MM WIDE X 40MM DEEP, 21CM
R-09-05	LANGENBECK RETRACTOR, 14MM WIDE X 33MM DEEP, 21CM
R-09-06	LANGENBECK RETRACTOR, 13MM WIDE X 42MM DEEP, 21CM
R-09-07	LANGENBECK RETRACTOR, 16MM WIDE X 42MM DEEP, 21CM

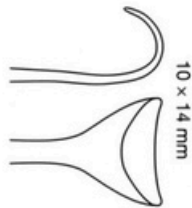
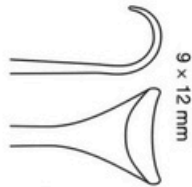
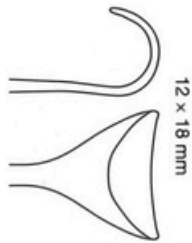
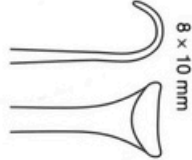
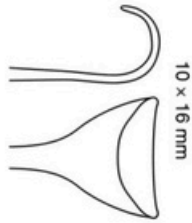

Item CodeDescription

R-09-15	DESMARRES LID RETRACTOR #0, 14CM, PEDIATRIC, 8X10MM
R-09-16	DESMARRES LID RETRACTOR #1, 14CM, SMALL, 9X12MM
R-09-17	DESMARRES LID RETRACTOR #2, 14CM, MEDIUM, 10X14MM
R-09-18	DESMARRES LID RETRACTOR #3, 14CM, LARGE, 10X16MM
R-09-19	DESMARRES LID RETRACTOR #4, 14CM, EXTRA LARGE, 12X18MM

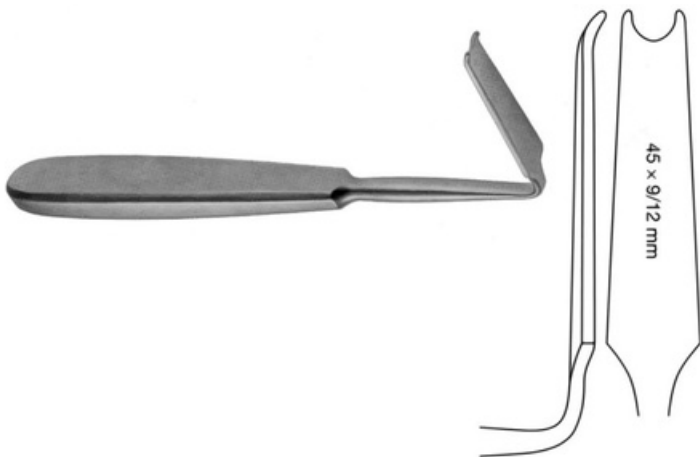

Item CodeDescription

R-09-34	OBWEGESER MANDIBULAR RIM RETRACTOR, 17CM, 9/12 X 45MM
---------	---

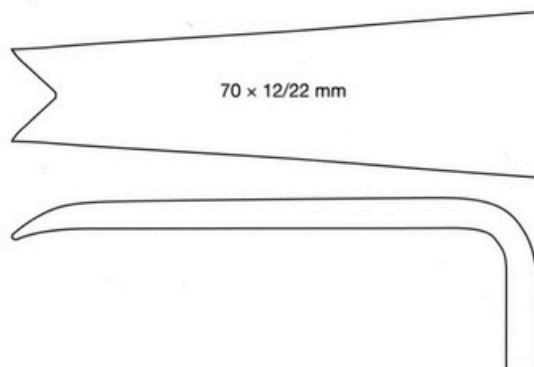
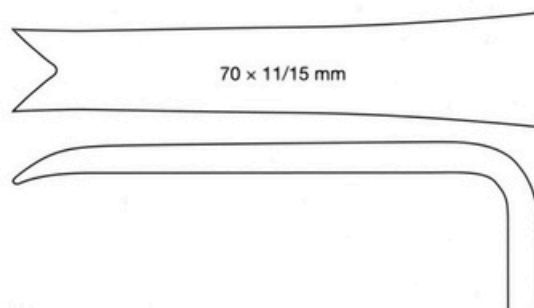

Item Code	Description
R-09-35	OBWEGESER RAMUS RETRACTOR, 22CM, 11/15 X 70MM
R-09-36	OBWEGESER RAMUS RETRACTOR, 22CM, 12/22 X 70MM

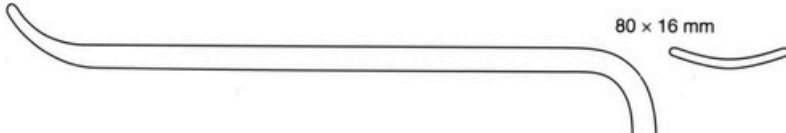
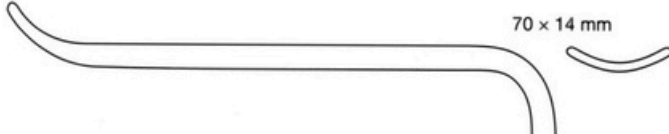
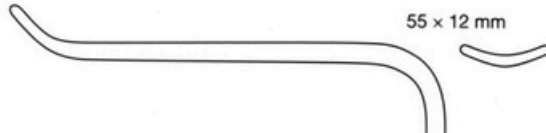
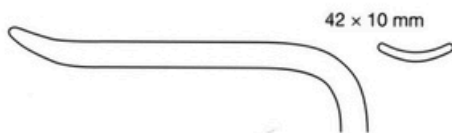
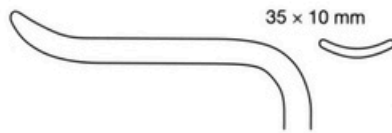
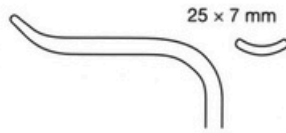
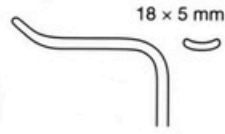

Item Code	Description
R-09-20	OBWEGESER SOFT TISSUE RETRACTOR, 23CM, 5X18MM, CURVED UP
R-09-21	OBWEGESER SOFT TISSUE RETRACTOR, 23CM, 7X25MM, CURVED UP
R-09-22	OBWEGESER SOFT TISSUE RETRACTOR, 23CM, 10X35MM, CURVED UP
R-09-23	OBWEGESER SOFT TISSUE RETRACTOR, 23CM, 10X42MM, CURVED UP
R-09-24	OBWEGESER SOFT TISSUE RETRACTOR, 23CM, 12X55MM, CURVED UP
R-09-25	OBWEGESER SOFT TISSUE RETRACTOR, 23CM, 14X70MM, CURVED UP
R-09-26	OBWEGESER SOFT TISSUE RETRACTOR, 23CM, 16X80MM, CURVED UP

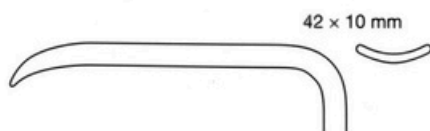
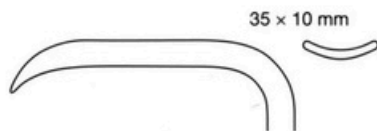
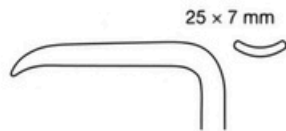
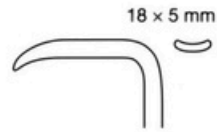

Item Code	Description
R-09-27	OBWEGESER SOFT TISSUE RETRACTOR, 23CM, 5X18MM, CURVED DOWN
R-09-28	OBWEGESER SOFT TISSUE RETRACTOR, 23CM, 7X25MM, CURVED DOWN
R-09-29	OBWEGESER SOFT TISSUE RETRACTOR, 23CM, 10X35MM, CURVED DOWN
R-09-30	OBWEGESER SOFT TISSUE RETRACTOR, 23CM, 10X42MM, CURVED DOWN
R-09-31	OBWEGESER SOFT TISSUE RETRACTOR, 23CM, 12X55MM, CURVED DOWN
R-09-32	OBWEGESER SOFT TISSUE RETRACTOR, 23CM, 14X70MM, CURVED DOWN
R-09-33	OBWEGESER SOFT TISSUE RETRACTOR, 23CM, 16X80MM, CURVED DOWN



Item Code	Description
R-09-37	OBWEGESER ALVEOLAR (WISDOM TOOTH) RETRACTOR, 22CM, 13/23 X 70MM

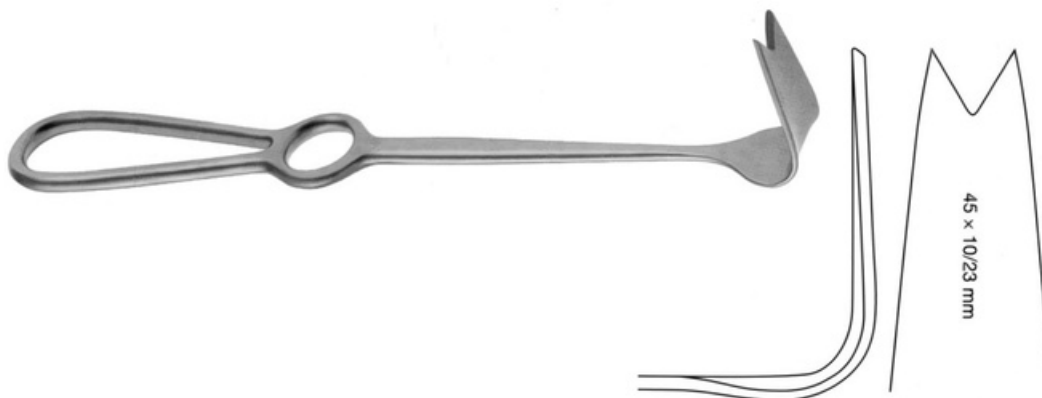

Item Code	Description
R-09-38	OBWEGESER NASAL SPINE RETRACTOR, 22CM, 10/23 X 45MM

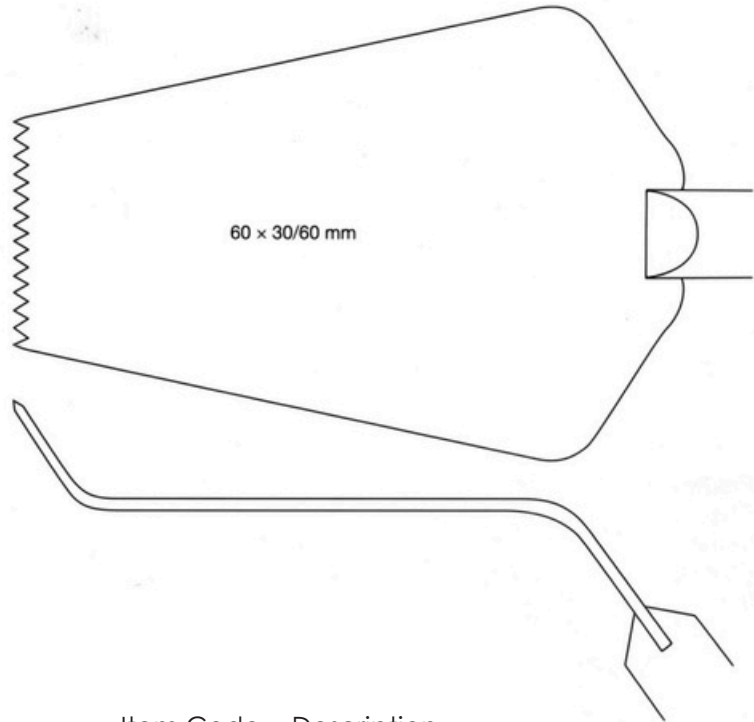

Item Code	Description
R-09-39	OBWEGESER ILIAC CREST RETRACTOR, 22CM, 30/60 X 60MM

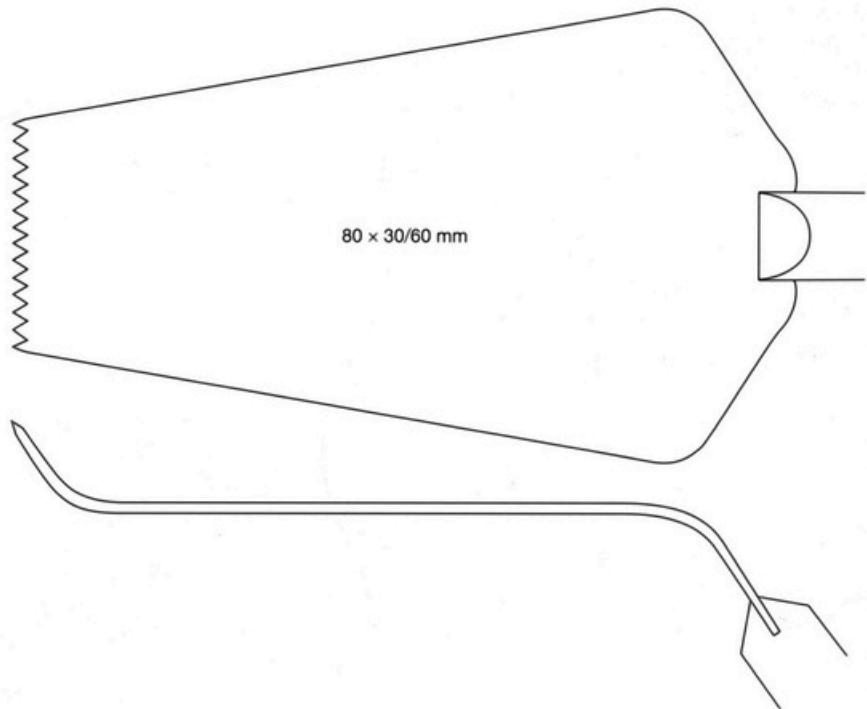

Item Code	Description
R-09-40	OBWEGESER ILIAC CREST RETRACTOR, 22CM, 30/60 X 80MM

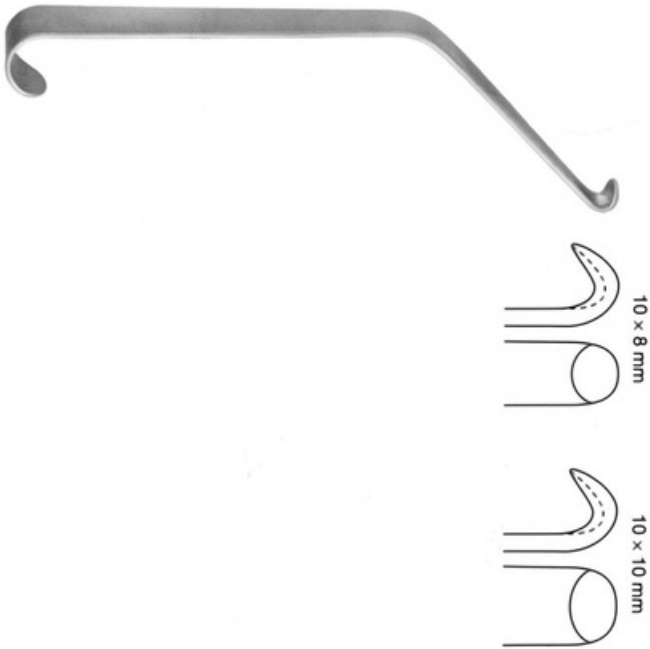

Item Code	Description
R-09-41	OBWEGESER MANDIBULAR CHANNEL RETRACTOR, 17.5CM, 8MM
R-09-42	OBWEGESER MANDIBULAR CHANNEL RETRACTOR, 17.5CM, 10MM

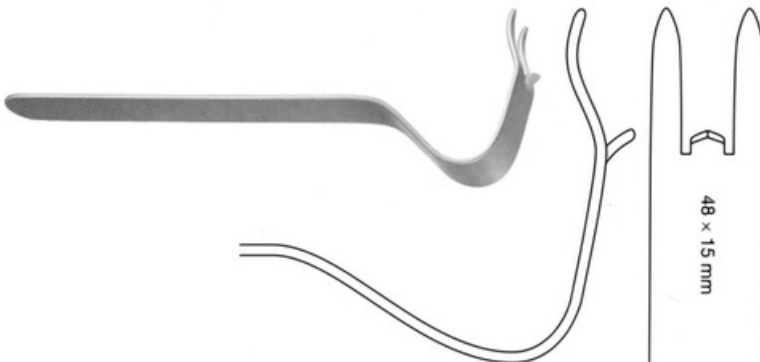

Item Code	Description
R-09-43	OBWEGESER CHIN RETRACTOR, 16CM



Item Code	Description
R-09-50	SALDANHA SOLZ ABDOMINAL RETRACTOR, 23.5CM



Item Code	Description
R-09-51	Coronal Brow Lift 7 Prongs Retractor, 18 cm



Item Code	Description
R-09-52	Anderson Bear Claw Retractor, 12 cm



Item Code	Description
R-09-57-01	Sculpo Breast Retractors, 180 X 25mm Blade Size, With 5mm Endoscopic Scope Sheath
R-09-57-02	Sculpo Breast Retractors, 180 X 25mm Blade Size, With 10mm Endoscopic Scope Sheath



Item Code	Description
R-09-58	Killian Nasal Speculum With Fiber Optics Illumination



Item Code	Description
R-09-59-01	Freeman Flap Retractor With Fiber Optics Illumination, 20cm, 13mm
R-09-59-02	Freeman Flap Retractor With Fiber Optics Illumination, 20cm, 25mm



Item Code	Description
R-09-60-01	Deaver Retractor With Fiber Optics Illumination, 16mm
R-09-60-02	Deaver Retractor With Fiber Optics Illumination, 25mm



Item Code	Description
R-09-61	Ferreira Face Lift Retractor With Fiber Optic Illumination 22 X 108mm



Item Code	Description
R-09-62	Ring breast retractor with fiber optic illumination and irrigation tube

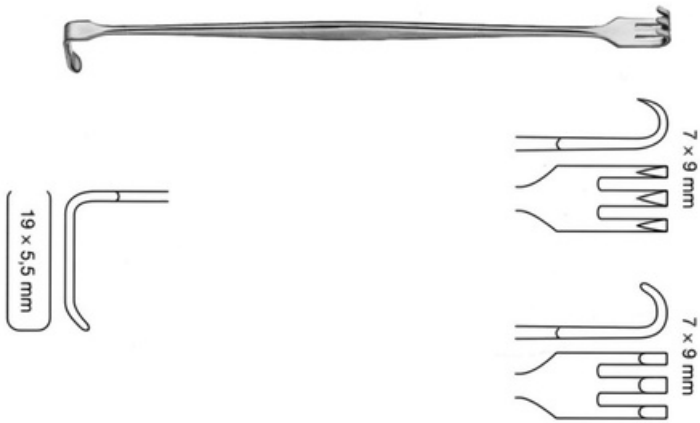

Item CodeDescription

DR-10-01	SENN MILLER RETRACTOR, 16CM, SHARP
DR-10-02	SENN MILLER RETRACTOR, 16CM, BLUNT



Item CodeDescription

DR-10-03	RAGNELL DOUBLE ENDED RETRACTOR, 16CM
----------	--------------------------------------



Item CodeDescription

DR-10-04	COPE RETRACTOR, 18CM, DOUBLE ENDED, 6MM/11MM
----------	--

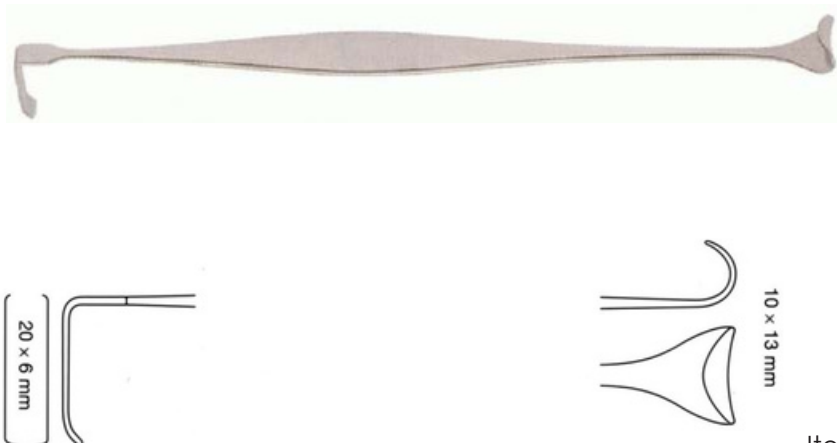

Item CodeDescription

DR-10-05	WALTER COPE RETRACTOR, 17.5CM
----------	-------------------------------

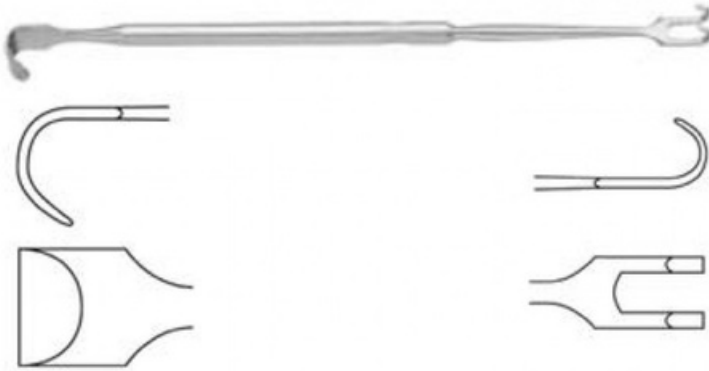

Item Code Description

DR-10-06	JACKSON TRACHEAL RETRACTOR, 17CM, DOUBLE ENDED
----------	---

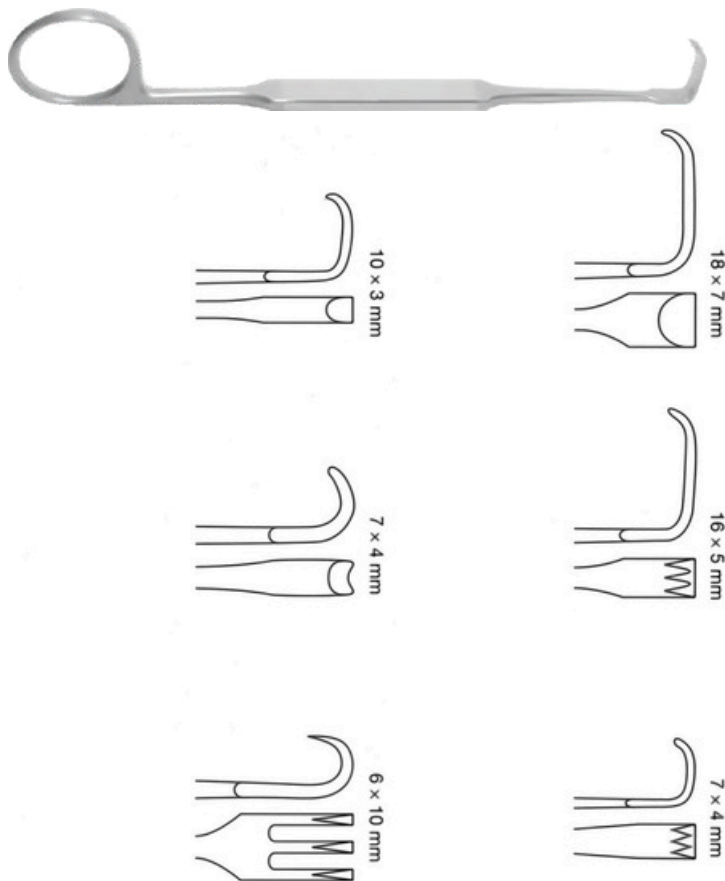

Item Code Description

DR-10-07	MEYERDING RETRACTOR, 18CM, 7X18MM
DR-10-08	MEYERDING RETRACTOR, 18CM, TOOTHED, 5X16MM
DR-10-09	MEYERDING RETRACTOR, 18CM, TOOTHED, 4X7MM
DR-10-10	MEYERDING RETRACTOR, 18CM, 3X10MM
DR-10-11	MEYERDING RETRACTOR, 18CM, CONCAVE BLADE, 4X7MM
DR-10-12	MEYERDING RETRACTOR, 18CM, 3 PRONGS, 4X10MM

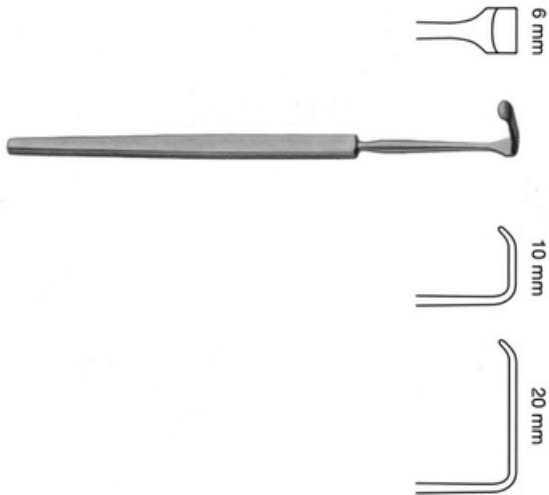

Item Code	Description
DR-10-13	SENN GREEN RETRACTOR, 14CM, 6X10MM
DR-10-15	SENN GREEN RETRACTOR, 14CM, 6X20MM

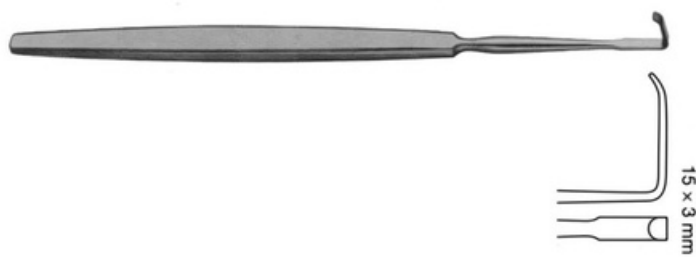

Item Code	Description
DR-10-14	LANZ RETRACTOR, 18CM, 3X15MM

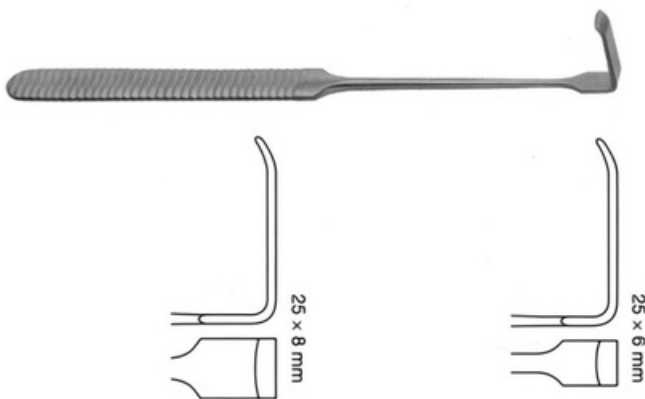

Item Code	Description
DR-10-16	LANGENBECK GREEN RETRACTOR, 17CM, 6X25MM
DR-10-17	LANGENBECK GREEN RETRACTOR, 17CM, 8X25MM

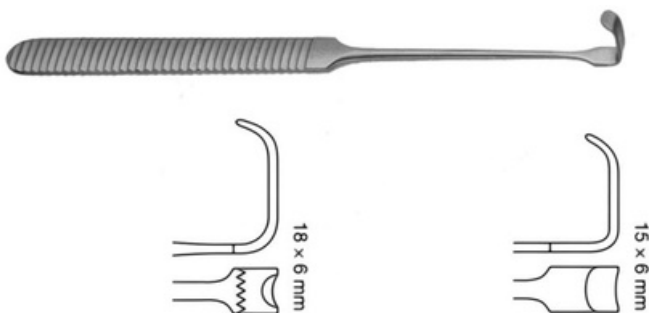

Item Code	Description
DR-10-18	STRANDELL STILLE RETRACTOR, 17CM, BLUNT, 6X15MM
DR-10-19	STRANDELL STILLE RETRACTOR, 17CM, TOOTHED, 6X15MM



Item Code	Description
DR-10-23	FRAZIER DURA AND SKIN RETRACTOR HOOK, 12.5CM, 3MM



Item Code	Description
DR-10-26	STRAIGHT SKIN HOOK, 13CM, STRAIGHT, 4MM



Item Code	Description
DR-10-27	LAHEY CLINIC DURA RETRACTOR HOOK, 13CM, 2MM



Item Code	Description
DR-10-20	ADSON HOOK, 20CM, SHARP, 3MM
DR-10-21	ADSON HOOK, 20CM, BLUNT, 3MM



Item Code	Description
DR-10-24	GILLIES DURA AND SKIN RETRACTOR HOOK, 19CM, SMALL
DR-10-25	GILLIES DURA AND SKIN RETRACTOR HOOK, 19CM, LARGE



Item Code	Description
DR-10-29	HUMBY SWIVEL SKIN HOOK, 11.5CM, 2 PRONGS, 3MM



Item Code	Description
DR-10-28-01	BARSKY SKIN HOOK, 15CM, SHARP, Single Prong
DR-10-28-02	BARSKY SKIN HOOK, 15CM, SHARP, Double Prong



Item Code	Description
DR-10-36	KLEINERT KUTZ SKIN HOOK, 13CM, SHARP, SMALL, 3MM WIDE
DR-10-37	KLEINERT KUTZ SKIN HOOK, 13CM, SHARP, MEDIUM, 5MM WIDE
DR-10-38	KLEINERT KUTZ SKIN HOOK, 13CM, SHARP, LARGE, 7MM WIDE

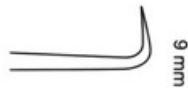

Item Code	Description
DR-10-30	CKSON TRACHEAL TENACULUM , 14.5CM, SINGLE, 9MM



Item Code	Description
DR-10-31	NEWS TRACHEOTOMY HOOK, 15CM, SINGLE, 10MM

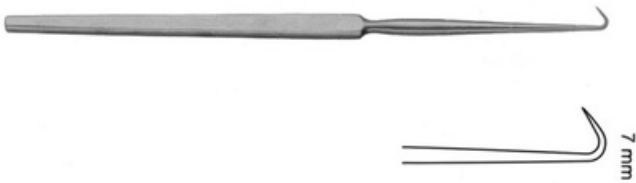

Item Code	Description
DR-10-32	COTTLE TENACULUM HOOK, 16CM, ANGLED, 7MM



Item Code	Description
DR-10-33	EMMETT TENACULUM HOOK #1, 22CM, SHARP, 6MM



Item Code	Description
DR-10-34	BERGMANN RETRACTOR HOOK, 14CM, SINGLE PRONG, SHARP, 8MM

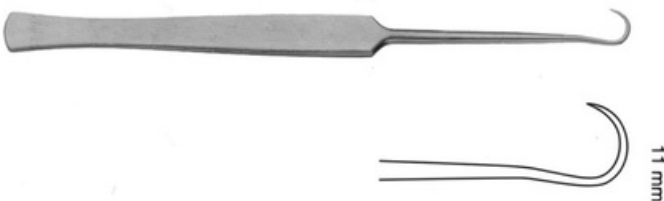

Item Code	Description
DR-10-35	HOOK RETRACTOR, 16.5CM, SINGLE PRONG, SHARP, 11MM



Item Code	Description
DR-10-39	BENICKE RETRACTOR, 19CM, 8MM, SHARP, S SHAPED TIP
DR-10-40	BENICKE RETRACTOR, 19CM, 8MM, BLUNT, S SHAPED TIP



Item Code	Description
DR-10-41	JOSEPH SKIN HOOK, 16CM, SINGLE PRONG, SHARP, 5MM



Item Code	Description
DR-10-46	FREER DOUBLE HOOK, 15CM, SHARP, 3MM WIDE

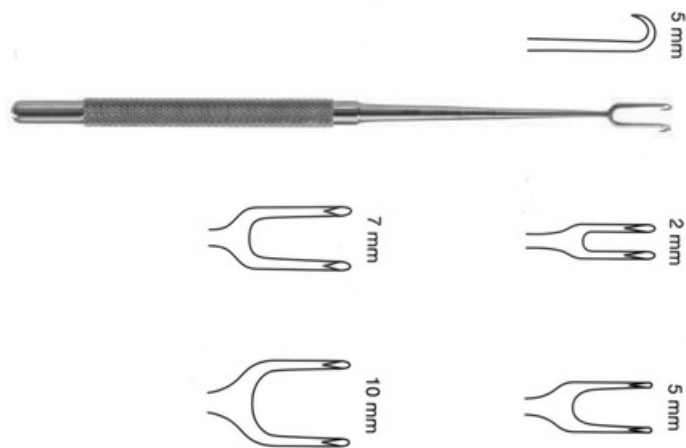

Item Code	Description
DR-10-42	JOSEPH SKIN HOOK, 16CM, DOUBLE PRONG, SHARP, 2MM WIDE
DR-10-43	JOSEPH DELICATE RETRACTOR, 17CM, 2 PRONG, 5MM, SHARP
DR-10-44	JOSEPH SKIN HOOK, DOUBLE PRONG, SHARP, 17CM, 7MM WIDE
DR-10-45	JOSEPH SKIN HOOK, DOUBLE PRONG, SHARP, 16CM, 10MM WIDE

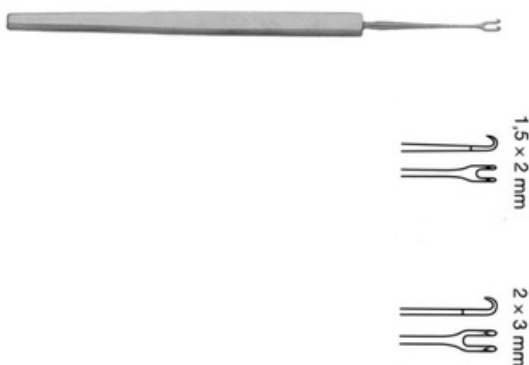

Item Code	Description
DR-10-47	GUTHRIE DOUBLE RETRACTOR HOOK, 13CM, SHARP, 1.5MM X 2MM WIDE
DR-10-48	GUTHRIE DOUBLE RETRACTOR HOOK, 13CM, SHARP, 2MM X 3MM WIDE

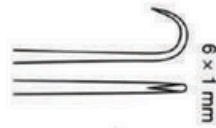

6 x 1 mm

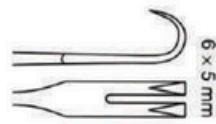

6 x 5 mm

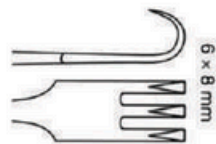

6 x 8 mm



6 x 11 mm

Item CodeDescription

DR-10-49	RETRACTOR, SINGLE PRONG, SHARP, 17CM
DR-10-50	RETRACTOR, 2 PRONGS, SHARP, 5MM WIDE, 17CM
DR-10-51	RETRACTOR, 3 PRONG, SHARP, 8MM WIDE, 17CM
DR-10-52	RETRACTOR, 4 PRONG, SHARP, 11MM WIDE, 17CM

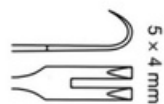

5 x 4 mm

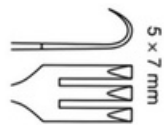

5 x 7 mm



5 x 4 mm



5 x 7 mm

Item CodeDescription

DR-10-57	FLEXIBLE NECK RETRACTOR, 16CM, 2 PRONG, SHARP, 4MM WIDE
DR-10-58	FLEXIBLE NECK RETRACTOR, 16CM, 3 PRONG, SHARP, 7MM WIDE
DR-10-59	FLEXIBLE NECK RETRACTOR, 16CM, 2 PRONG, BLUNT, 4MM WIDE
DR-10-60	FLEXIBLE NECK RETRACTOR, 16CM, 3 PRONG, BLUNT, 7MM WIDE

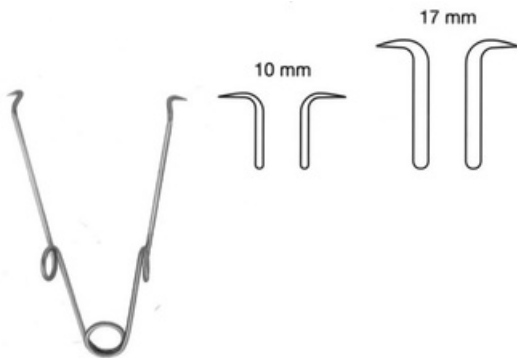

Item CodeDescription

SRR-11-01	SPRING RETRACTOR, 8.5CM, 1X1 SHARP PRONGS
SRR-11-02	SPRING RETRACTOR, 11.5CM, 1X1 SHARP PRONGS
SRR-11-03	SPRING RETRACTOR, 8.5CM, 3X3 BLUNT PRONGS
SRR-11-04	SPRING RETRACTOR, 11.5CM, 3X3 BLUNT PRONGS

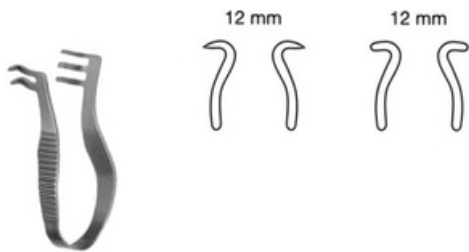

Item CodeDescription

SRR-11-06	FINSEN RETRACTOR, 5CM, 2X3 SHARP PRONGS
SRR-11-07	FINSEN RETRACTOR, 5CM, 2X3 BLUNT PRONGS

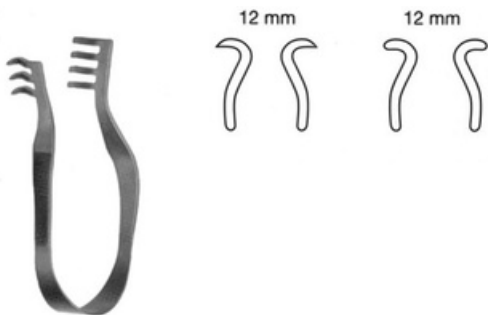

Item CodeDescription

SRR-11-08	FINSEN RETRACTOR, 7CM, 3X4 SHARP PRONGS
SRR-11-09	FINSEN RETRACTOR, 7CM, 3X4 BLUNT PRONGS

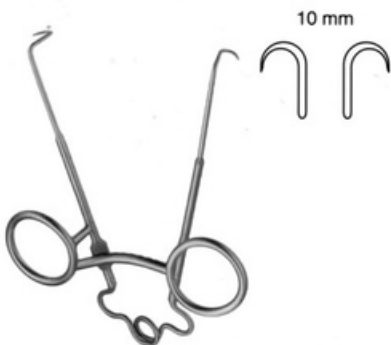

Item CodeDescription

SRR-11-05	SPRING RETRACTOR, 10.5CM, 1X1 SHARP PRONGS, WITH RATCHET
-----------	--

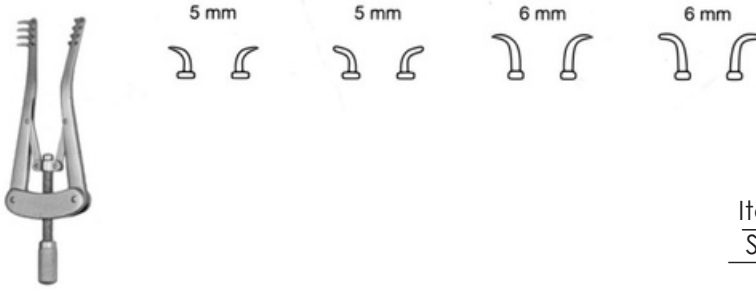

Item Code	Description
SRR-11-14	ALM RETRACTOR, 7CM, 4X4 SHARP PRONGS, 5MM DEEP
SRR-11-15	ALM RETRACTOR, 7CM, 4X4 BLUNT PRONGS, 5MM DEEP
SRR-11-16	ALM RETRACTOR, 10CM, 4X4 SHARP PRONGS, 6MM DEEP
SRR-11-17	ALM RETRACTOR, 10CM, 4X4 BLUNT PRONGS, 6MM DEEP

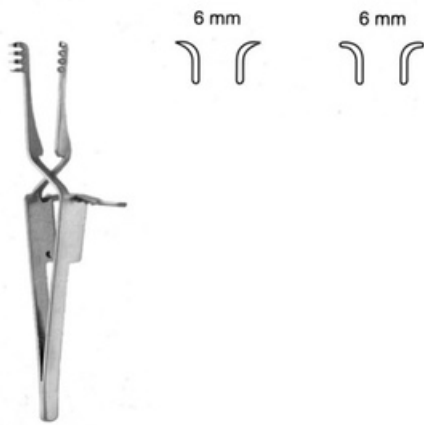

Item Code	Description
SRR-11-12	SKIN RETRACTOR, 10CM, CROSS ACTION, 4X4 SHARP PRONGS
SRR-11-13	SKIN RETRACTOR, 10CM, CROSS ACTION, 4X4 BLUNT PRONGS

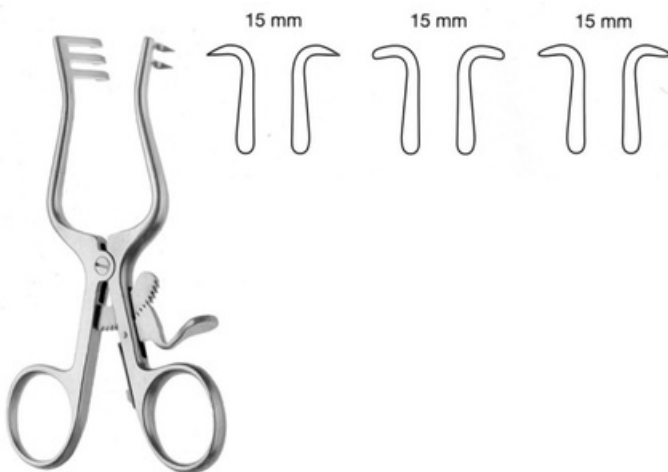

Item Code	Description
SRR-11-19	WEITLANER RETRACTOR, 2X3 SHARP PRONGS, 15MM DEEP, 10.5CM
SRR-11-20	WEITLANER RETRACTOR, 2X3 BLUNT PRONGS, 15MM DEEP, 10.5CM
SRR-11-21	WEITLANER RETRACTOR, 2X3 SEMI SHARP PRONGS, 15MM DEEP, 10.5CM

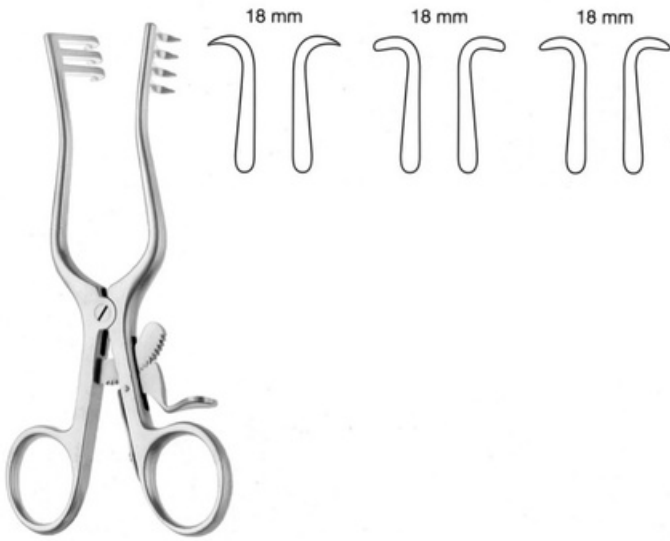

Item Code	Description
SRR-11-25	WEITLANER RETRACTOR, 3X4 SHARP PRONGS, 18MM DEEP, 16.5CM
SRR-11-26	WEITLANER RETRACTOR, 3X4 BLUNT PRONGS, 18MM DEEP, 16.5CM
SRR-11-27	WEITLANER RETRACTOR, 3X4 SEMI-SHARP PRONGS, 18MM DEEP, 16.5CM



Item Code	Description
SRR-11-18	WEITLANER RETRACTOR, SOLID BLADES, 18MM DEEP, 13CM



Item Code	Description
BH-12-09	SCALPEL HANDLE, #3 STANDARD



Item Code	Description
BH-12-10	SCALPEL HANDLE, #7



Item Code	Description
BH-12-11	SCALPEL HANDLE, #3 LONG



Item Code	Description
BH-12-12	SCALPEL HANDLE, #7K SHORT



Item Code	Description
BH-12-14	SCALPEL HANDLE, #3LA LONG ANGLED



Item Code	Description
BH-12-16	SCALPEL, ROUND HANDLE, 16CM



Item Code	Description
BH-12-17	SCALPEL HANDLE, LONG SLIM, 22.5CM



Item Code	Description
BH-12-18	SCALPEL, ROUND HANDLE, LONG, 27CM



Item Code	Description
BH-12-19	SCALPEL HANDLE, BAYONET TYPE, 21CM



Item Code	Description
BH-12-20	SCALPEL HANDLE, #4L LONG



Item Code	Description
BH-12-30	SCALPEL HANDLE, #3, WITH SCALE
