



Hardi

Surgical & Dental Instruments





Biemer Clip Applying Forcep
Without Lock

Catalog #	Size
MP04-010-14	14.5 cm (5 3/4")



Biemer Clip Applying Forcep
With Lock

Catalog #	Size
MP04-012-14	14.5 cm (5 3/4")

Biemer Vessel Clip

Catalog #	Size, Opening, Jaw Length, Closing Pressure
MP04-016-14	14 mm, 4 mm, 4 mm, 30 - 40 gr



Biemer Vessel Clip

Catalog #	Size, Opening, Jaw Length, Closing Pressure
MP04-018-17	17 mm, 7 mm, 5 mm, 30 - 40 gr



Biemer Vessel Clip

Catalog #	Size, Opening, Jaw Length, Closing Pressure
MP04-020-17	17 mm, 7 mm, 5 mm, 20 - 25 gr



Biemer-Mueller Approximator

Straight, Wide

Catalog #	Size, Opening, Jaw Length, Closing Pressure
MP04-024-17	17 mm, 5 mm, 9 mm, 25 - 30 gr

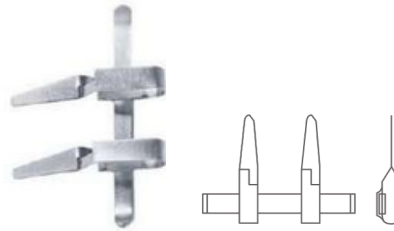

Biemer-Mueller Approximator

Angled, Wide

Catalog #	Size, Opening, Jaw Length, Closing Pressure
MP04-025-17	17 mm, 5 mm, 9 mm, , 25 - 30 gr

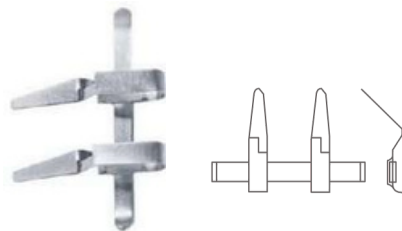

Biemer-Mueller Approximator

Straight, Narrow

Catalog #	Size, Opening, Jaw Length, Closing Pressure
MP04-026-13	13 mm, 3 mm, 4.5 mm, 25 - 30 gr
MP04-026-17	17 mm, 5 mm, 9 mm, , 25 - 30 gr

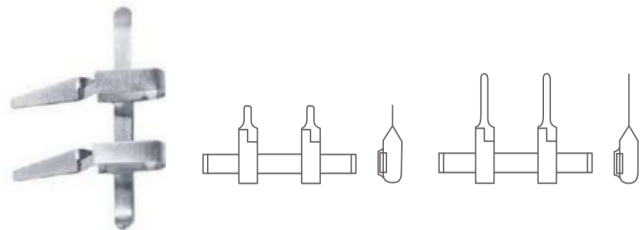

Biemer-Mueller Approximator

Angled, Narrow

Catalog #	Size, Opening, Jaw Length, Closing Pressure
MP04-027-17	17 mm, 5 mm, 9 mm. 25 - 30 gr

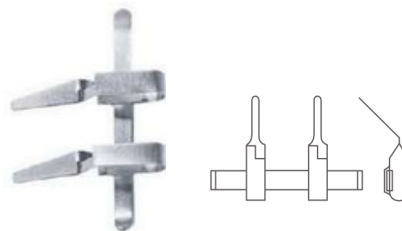

Mueller Approximator

Catalog #	Size, Diameter, Closing Pressure
MP04-030-01	17 mm, Ø 1 mm, 25 - 30 gr
MP04-030-02	17 mm, Ø 2 mm, 25 - 30 gr
MP04-030-03	17 mm, Ø 3 mm, 25 - 30 gr
MP04-030-04	17 mm, Ø 4 mm, 25 - 30 gr

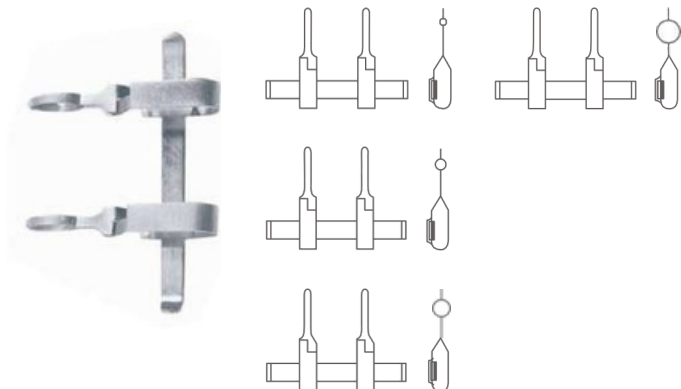

Nerve Approximator
Complete With Key

Catalog #	Size
MP04-040-00	Standard



Key For Approximator

Catalog #	Size
MP04-040-01	Standard



Nerve Approximator
Approximator Only

Catalog #	Size
MP04-040-02	Standard



Nerve Approximator- Complete With Key
Needles Exchangeable by Mean of Key

Catalog #	Size
MP04-044-00	Standard



Nerve Approximator
Approximator With Needles Only

Catalog #	Size
MP04-044-02	Standard



Nerve Approximator
Spare Needles Only

Catalog #	Size
MP04-044-04	Standard



Clip Applying Forcep
With Ratchet

Catalog #	Size
MP04-046-14	Standard



Clip Applying Forcep
Bayonet Shaped, With Ratchet

Catalog #	Size
MP04-049-18	18.5 cm (7 1/4")



Mini Vessel Clip

Catalog #	Size, Jaw Size, Closing Pressure
MP04-050-04	13 mm, 4.0 x 0.75 mm, 60 gr
MP04-050-06	15 mm, 6.0 x 1.0 mm, 85 gr
MP04-050-08	17 mm, 8.0 x 2.0 mm, 100 gr
MP04-050-10	20 mm, 10.0 x 2.0 mm, 125 gr



Dieffenbach Bulldog Clamp Straight

Catalog #	Size
MP04-060-06	6 cm (2 1/4")



Dieffenbach Bulldog Clamp Curved

Catalog #	Size
MP04-061-06	6 cm (2 1/4")



Dieffenbach Bulldog Clamp Straight

Catalog #	Size
MP04-062-03	3.5 cm (1 1/2")
MP04-062-05	5 cm (2")



Dieffenbach Bulldog Clamp Curved

Catalog #	Size
MP04-063-03	3.5 cm (1 1/2")
MP04-063-05	5 cm (2")



John-Hopkins Bulldog Clamp

Catalog #	Size
MP04-065-35	3.5 cm (1 1/2")
MP04-065-50	5 cm (2")
MP04-065-55	5.5 cm (2 1/2")
MP04-065-65	6.5 cm (2 1/2")
MP04-065-70	7 cm (2 3/4")
MP04-065-80	8 cm (3 1/4")
MP04-065-90	9 cm (3 1/2")



John-Hopkins Clip Applying Forcep

Catalog #	Size
MP04-067-24	24 cm (9 1/2")



Diethrich Bulldog Clamp Straight

Catalog #	Size, Jaw Length
MP04-080-45	45 mm, 8 mm
MP04-080-50	50 mm, 12 mm
MP04-080-60	60 mm, 20 mm



Diethrich Bulldog Clamp Angled

Catalog #	Size, Jaw Length
MP04-081-40	45 mm, 8 mm
MP04-081-45	50 mm, 12 mm
MP04-081-50	60 mm, 20mm





**DeBakey-Diethrich Atrauma Bulldog Clamp
Straight**

Catalog #	Size, Jaw Length
MP04-084-10	45 mm, 10 mm
MP04-084-14	50 mm, 14 mm
MP04-084-20	60 mm, 20mm

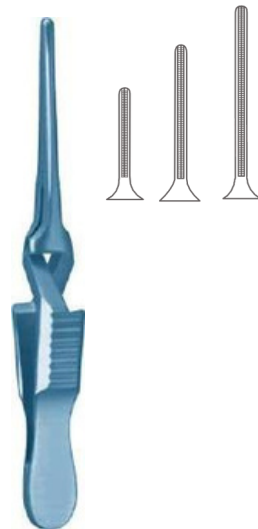

**DeBakey-Diethrich Atrauma Bulldog Clamp
Straight, Titanium**

Catalog #	Size, Jaw Length
MP04-084-10 T	45 mm, 10 mm
MP04-084-14 T	50 mm, 14 mm
MP04-084-20 T	60 mm, 20mm

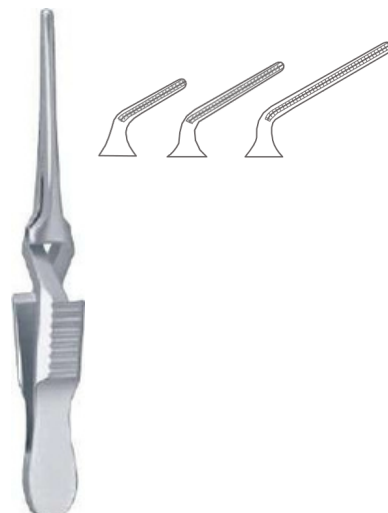

**DeBakey-Diethrich Atrauma Bulldog Clamp
Angled**

Catalog #	Size, Jaw Length
MP04-085-10	35 mm, 10 mm
MP04-085-14	45 mm, 14 mm
MP04-085-20	50 mm, 20 mm

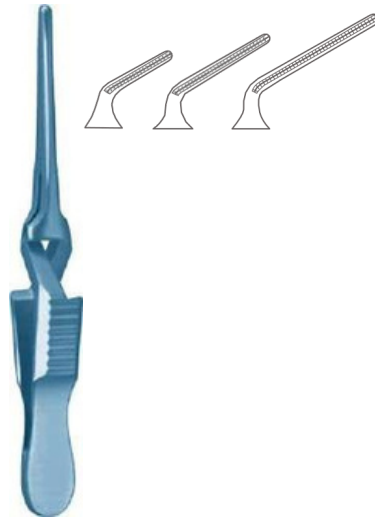

DeBakey-Diethrich Atrauma Bulldog Clamp
Angled, Titanium

Catalog #	Size, Jaw Length
MP04-085-10 T	35 mm, 10 mm
MP04-085-14 T	45 mm, 14 mm
MP04-085-20 T	50 mm, 20mm



DeBakey-Hess Bulldog Clamp

Catalog #	Size, Jaw Length
MP04-089-35	35 mm, 10 mm
MP04-089-40	40 mm, 10 mm

Mini-Glover Vena Atrauma Bulldog Clamp
Straight, Titanium

Catalog #	Size, Jaw Length
MP04-090-30 T	30 mm, 9 mm
MP04-090-35 T	35 mm, 13 mm
MP04-090-40 T	40 mm, 14 mm
MP04-090-50 T	50 mm, 23 mm



Mini-Glover Vena Atrauma Bulldog Clamp
Gently Curved, Titanium

Catalog #	Size, Jaw Length
MP04-091-30 T	30 mm, 9 mm
MP04-091-35 T	35 mm, 13 mm
MP04-091-40 T	40 mm, 14 mm
MP04-091-50 T	50 mm, 23 mm



Mini-Glover Vena Atrauma Bulldog Clamp
Strongly Curved, Titanium

Catalog #	Size, Jaw Length
MP04-093-30 T	30 mm, 9 mm
MP04-093-35 T	35 mm, 13 mm
MP04-093-40 T	40 mm, 14 mm
MP04-093-50 T	50 mm, 23 mm



Mini-Glover Arteria Atrauma Bulldog Clamp
Straight, Titanium

Catalog #	Size, Jaw Length
MP04-096-30 T	30 mm, 9 mm
MP04-096-35 T	35 mm, 13 mm
MP04-096-40 T	40 mm, 14 mm
MP04-096-50 T	50 mm, 23 mm



Mini-Glover Arteria Atrauma Bulldog Clamp
Gently Curved, Titanium

Catalog #	Size, Jaw Length
MP04-097-30 T	30 mm, 9 mm
MP04-097-35 T	35 mm, 13 mm
MP04-097-40 T	40 mm, 14 mm
MP04-097-50 T	50 mm, 22 mm



Mini-Glover Arteria Atrauma Bulldog Clamp
Strongly Curved, Titanium

Catalog #	Size, Jaw Length
MP04-099-30 T	30 mm, 10mm
MP04-099-35 T	35 mm, 14 mm
MP04-099-40 T	40 mm, 15 mm
MP04-099-50 T	50 mm, 21mm



Peen Haemostatic Forcep

Catalog #	Size
MP04-110-14	14.5 cm (5 ¾")
MP04-110-16	16 cm (6 ¼")



Korenlein Haemostatic Forcep

Catalog #	Size
MP04-112-13	13 cm (5")





Spencer-Wells Haemostatic Forcep
Straight

Catalog #	Size
MP04-114-13	13 cm (5")
MP04-114-14	14.5 cm (5 ¾")
MP04-114-15	15.5 cm (6")
MP04-114-18	18.5 cm (7 ¼")
MP04-114-20	20 cm (8")



Spencer-Wells Haemostatic Forcep
Curved

Catalog #	Size
MP04-115-13	13 cm (5")
MP04-115-14	14 cm (5 ¾")
MP04-115-15	15 cm (6")
MP04-115-18	18 cm (7 ¼")
MP04-115-20	20 cm (8")



Chaput Haemostatic Forcep
2 x 3 Teeth

Catalog #	Size
MP04-120-13	12.5 cm (5")



Tuffier Haemostatic Forcep
4 x 5 Teeth

Catalog #	Size
MP04-122-13	12.5 cm (5")



Atrauma Organ Grasping / Haemorrhoidal Forcep

Catalog #	Size
MP04-126-25	25 cm (9 3/4")
MP04-126-26	26 cm (10 1/4")



Collin Organ Grasping Forcep

Catalog #	Size
MP04-128-14	14 cm (5 1/2")



Collin Tumor Grasping Forcep

Catalog #	Size
MP04-130-17	17 cm (6 3/4")

Pennington Organ Grasping Forcep

Catalog #	Size
MP04-134-15	15.5 cm (6")
MP04-134-20	21 cm (8 1/4")



Pratt Haemostatic Forcep

Catalog #	Size
MP04-136-15	15 cm (6")

Martel-Rees Face-Lift Forcep

Catalog #	Size
MP04-138-14	13.5 cm (5 1/4")





Hartmann Haemostatic Forcep
Straight

Catalog #	Size
MP04-140-10	10 cm (4")



Hartmann Haemostatic Forcep
Curved

Catalog #	Size
MP04-141-10	9.5 cm (3 3/4")



Hartmann Haemostatic Forcep
Straight, 1 x 2 Teeth

Catalog #	Size
MP04-142-10	10 cm (4")



Hartmann Haemostatic Forcep
Curved, 1 x 2 Teeth

Catalog #	Size
MP04-143-10	9.5 cm (3 3/4")



Haemostatic Forcep
Cross Serrated Jaw

Catalog #	Size
MP04-146-12	12.5 cm (5")



Carrel Haemostatic Forcep

Catalog #	Size
MP04-148-08	8.5 cm (3 1/4")



Terrier Haemostatic Forcep
1 x 2 Teeth

Catalog #	Size
MP04-150-08	8.5 cm (3 1/4")



Halsted-Mosquito Haemostatic Forcep
Straight

Catalog #	Size
MP04-160-12	12.5 cm (4 3/4")
MP04-160-14	14.5 cm (5 1/2")



Halsted-Mosquito Haemostatic Forcep
Curved

Catalog #	Size
MP04-161-12	12 cm (4 3/4")
MP04-161-14	14 cm (5 1/2")





Halsted-Mosquito Haemostatic Forcep
Straight, 1 x 2 Teeth

Catalog #	Size
MP04-162-12	12.5 cm (4 3/4")
MP04-162-14	14.5 cm (5 3/4")

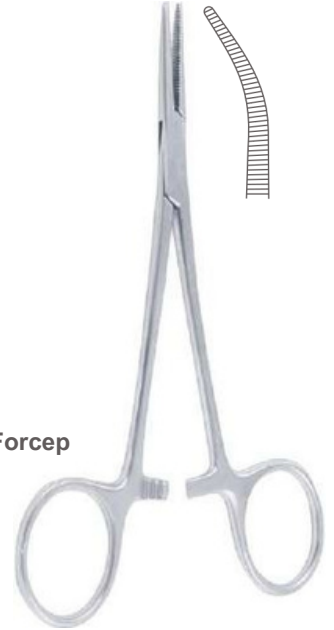

Halsted-Mosquito Haemostatic Forcep
Curved, 1 x 2 Teeth

Catalog #	Size
MP04-163-12	12 cm (4 3/4")
MP04-163-14	14 cm (5 1/2")



Micro-Mosquito Haemostatic Forcep
Straight

Catalog #	Size
MP04-170-10	10 cm (4")
MP04-170-12	12 cm (4 3/4")



Micro-Mosquito Haemostatic Forcep
Curved

Catalog #	Size
MP04-171-10	9.5 cm (3 3/4")
MP04-171-12	11.5 cm (4 1/2")



Micro-Mosquito Haemostatic Forcep Straight, 1 x 2 Teeth

Catalog #	Size
MP04-172-10	10 cm (4")
MP04-172-12	12 cm (4 ¾")



Micro-Mosquito Haemostatic Forcep Curved, 1 x 2 Teeth

Catalog #	Size
MP04-173-10	10 cm (4")
MP04-173-12	12 cm (4 ¾")



Halsted-Mosquito Haemostatic Forcep Straight

Catalog #	Size
MP04-176-18	18.5 cm (7 ¼")
MP04-176-21	21 cm (8 ¼")



Halsted-Mosquito Haemostatic Forcep Curved

Catalog #	Size
MP04-177-18	18 cm (7")
MP04-177-21	20.5 cm (8")



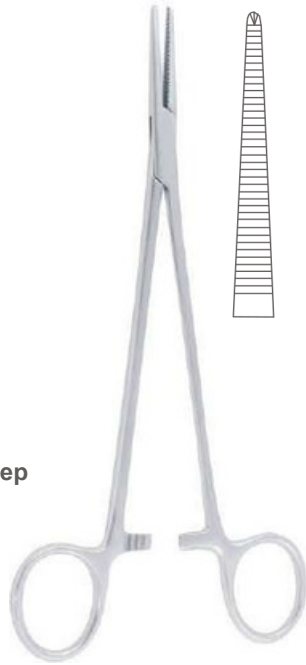

Halsted-Mosquito Haemostatic Forcep
Straight, 1 x 2 Teeth

Catalog #	Size
MP04-178-18	18.5 cm (7 1/4")
MP04-178-21	21 cm (8 1/4")



Halsted-Mosquito Haemostatic Forcep
Curved, 1 x 2 Teeth

Catalog #	Size
MP04-179-18	18 cm (7")
MP04-179-21	21 cm (8")



Providence-Hospital Haemostatic Forcep
Straight

Catalog #	Size
MP04-182-14	14 cm (5 1/2")



Providence-Hospital Haemostatic Forcep
Curved

Catalog #	Size
MP04-183-14	14 cm (5 1/2")



**Leriche Haemostatic Forcep
Straight**

Catalog #	Size
MP04-184-15	15.5 cm (6")



**Leriche Haemostatic Forcep
Curved**

Catalog #	Size
MP04-185-15	15 cm (6")



**Leriche Haemostatic Forcep
Straight, 1 x 2 Teeth**

Catalog #	Size
MP04-186-15	15.5 cm (6")



**Leriche Haemostatic Forcep
Curved, 1 x 2 Teeth**

Catalog #	Size
MP04-187-15	15 cm (6")





Kelly Haemostatic Forcep
Straight

Catalog #	Size
MP04-200-14	14.5 cm (5 3/4")



Kelly Haemostatic Forcep
Curved

Catalog #	Size
MP04-201-14	14 cm (5 1/2")



Kelly-Rankin Haemostatic Forcep
Straight

Catalog #	Size
MP04-202-16	16 cm (6 1/4")



Kelly-Rankin Haemostatic Forcep
Curved

Catalog #	Size
MP04-203-16	15.5 cm (6")



Crile Haemostatic Forcep
Straight

Catalog #	Size
MP04-210-14	14.5 cm (5 ¾")



Crile Haemostatic Forcep
Curved

Catalog #	Size
MP04-211-14	14 cm (5 ½")



Crile Haemostatic Forcep
Straight, 1 x 2 Teeth

Catalog #	Size
MP04-212-14	14 cm (5 ½")



Crile Haemostatic Forcep
Curved, 1 x 2 Teeth

Catalog #	Size
MP04-213-14	14 cm (5 ½")



Crile-Rankin Haemostatic Forcep
Straight

Catalog #	Size
MP04-214-16	17 cm (6 ¾")



Crile-Rankin Haemostatic Forcep
Curved

Catalog #	Size
MP04-215-16	17 cm (6 ¾")



Rochester-Pean Haemostatic Forcep
Straight

Catalog #	Size
MP04-220-14	14.5 cm (5 ¾")
MP04-220-16	16.5 cm (6 ½")
MP04-220-18	18.5 cm (7 ¼")
MP04-220-20	20.5 cm (8")
MP04-220-22	22.5 cm (8 ¾")
MP04-220-24	24.5 cm (9 ¾")
MP04-220-26	26 cm (10 ¼")
MP04-220-30	30.5 cm (12")

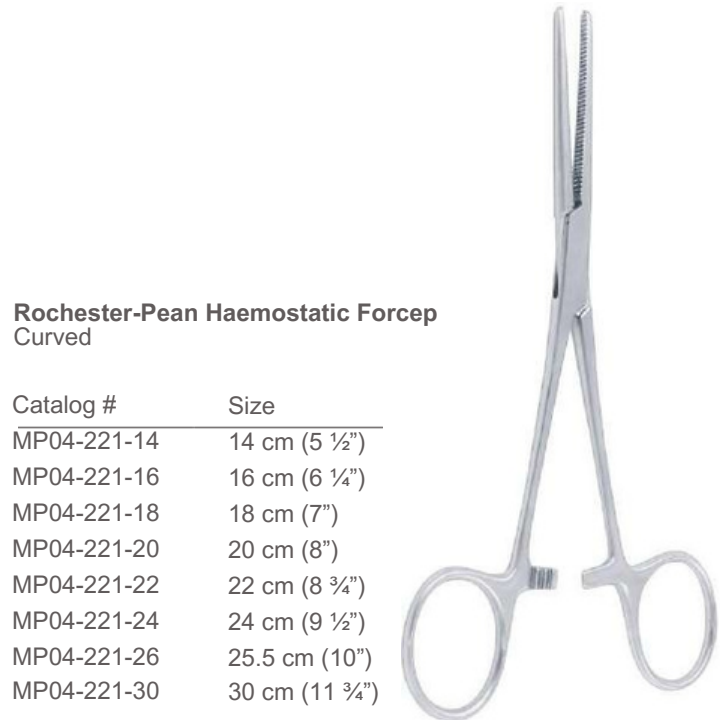

Rochester-Pean Haemostatic Forcep
Curved

Catalog #	Size
MP04-221-14	14 cm (5 ½")
MP04-221-16	16 cm (6 ¼")
MP04-221-18	18 cm (7")
MP04-221-20	20 cm (8")
MP04-221-22	22 cm (8 ¾")
MP04-221-24	24 cm (9 ½")
MP04-221-26	25.5 cm (10")
MP04-221-30	30 cm (11 ¾")

Ochsner-Kocher Haemostatic Forcep
Straight, 1 x 2 Teeth

Catalog #	Size
MP04-230-14	14.5 cm (5 ¾")
MP04-230-16	16.5 cm (6 ½")
MP04-230-18	18.5 cm (7 ¼")
MP04-230-20	20.5 cm (8")
MP04-230-22	22.5 cm (8 ¾")
MP04-230-24	24.5 cm (9 ¾")
MP04-230-26	26 cm (10 ¼")
MP04-230-30	30.5 cm (12")



Ochsner-Kocher Haemostatic Forcep
Curved, 1 x 2 Teeth

Catalog #	Size
MP04-231-14	14 cm (5 ½")
MP04-231-16	16 cm (6 ¼")
MP04-231-18	18 cm (7")
MP04-231-20	20 cm (8")
MP04-231-22	22 cm (8 ¾")
MP04-231-24	24 cm (9 ½")
MP04-231-26	25.5 cm (10 ")
MP04-231-30	30 cm (11 ¾")



Rochester-Ochsner Haemostatic Forcep
Straight

Catalog #	Size
MP04-234-14	14 cm (5 ½")



Rochester-Ochsner Haemostatic Forcep
Curved

Catalog #	Size
MP04-235-14	14 cm (5 ½")





Kocher Haemostatic Forcep
Straight, 1 x 2 Teeth

Catalog #	Size
MP04-236-15	15 cm (6")

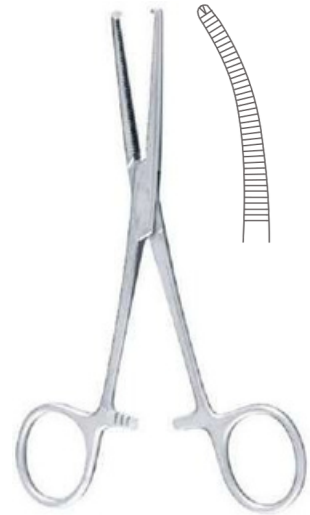

Kocher Haemostatic Forcep
Curved, 1 x 2 Teeth

Catalog #	Size
MP04-237-15	15 cm (6")



Pean-Nippon Haemostatic Forcep
Straight

Catalog #	Size
MP04-240-14	14.5 cm (5 ¾")
MP04-240-16	16.5 cm (6 ½")
MP04-240-18	18.5 cm (7 ¼")



Pean-Nippon Haemostatic Forcep
Curved

Catalog #	Size
MP04-241-14	14 cm (5 ½")
MP04-241-16	16 cm (6 ¼")
MP04-241-18	18 cm (7")



Kocher-Nippon Haemostatic Forcep
Straight, 1 x 2 Teeth

Catalog #	Size
MP04-242-14	14.5 cm (5 3/4")
MP04-242-16	16.5 cm (6 1/2")
MP04-242-18	18.5 cm (7 1/4")



Kocher-Nippon Haemostatic Forcep
Curved, 1 x 2 Teeth

Catalog #	Size
MP04-243-14	14.5 cm (5 3/4")
MP04-243-16	16 cm (6 1/4")
MP04-243-18	18 cm (7")



Pean (Delicate) Haemostatic Forcep
Straight

Catalog #	Size
MP04-246-13	13.5 cm (5 1/4")
MP04-246-14	14.5 cm (5 3/4")
MP04-246-16	17 cm (6 3/4")



Pean (Delicate) Haemostatic Forcep
Curved

Catalog #	Size
MP04-247-13	13 cm (5")
MP04-247-14	14 cm (5 1/2")
MP04-247-16	16.5 cm (6 1/2")



Kocher (Delicate) Haemostatic Forcep
Straight, 1 x 2 Teeth

Catalog #	Size
MP04-248-13	13 cm (5")
MP04-248-14	14 cm (5 ½")
MP04-248-17	16 cm (6 ¼")

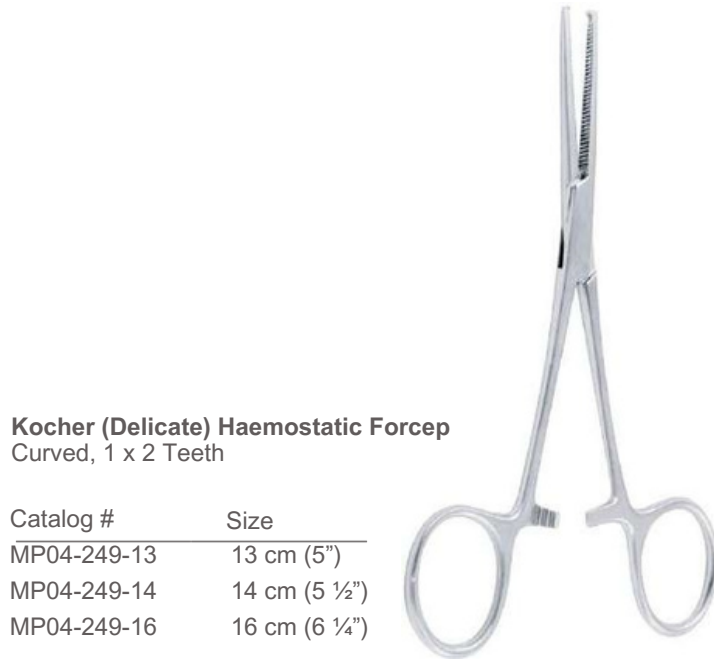

Kocher (Delicate) Haemostatic Forcep
Curved, 1 x 2 Teeth

Catalog #	Size
MP04-249-13	13 cm (5")
MP04-249-14	14 cm (5 ½")
MP04-249-16	16 cm (6 ¼")

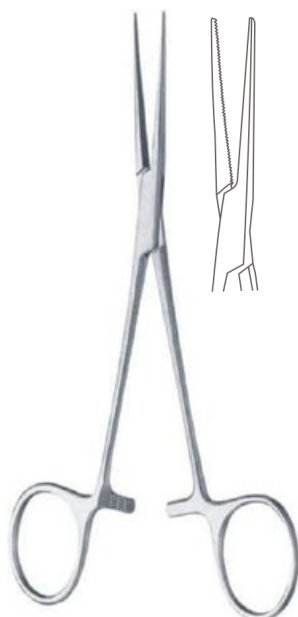

Coller Haemostatic Forcep
Straight

Catalog #	Size
MP04-260-14	14 cm (5 ½")
MP04-260-16	16.5 cm (6 ½")
MP04-260-18	18.5 cm (7 ¼")

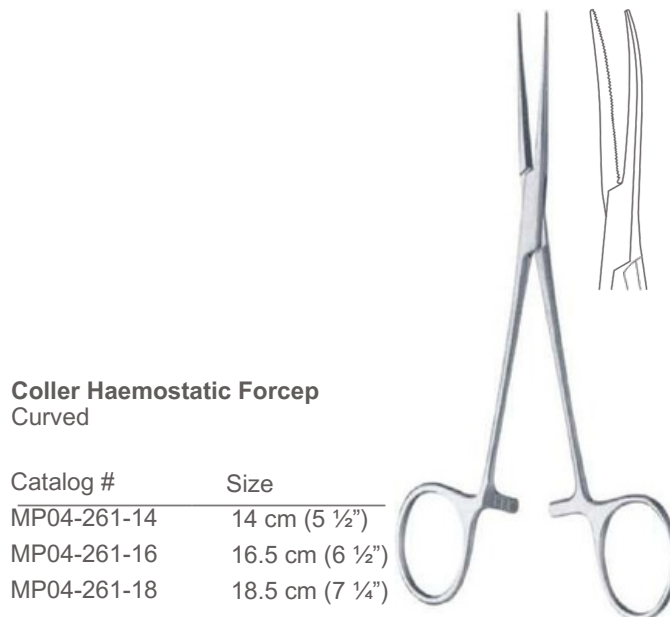

Coller Haemostatic Forcep
Curved

Catalog #	Size
MP04-261-14	14 cm (5 ½")
MP04-261-16	16.5 cm (6 ½")
MP04-261-18	18.5 cm (7 ¼")



Fraser-Kelly (Crile) Haemostatic Forcep
Curved

Catalog #	Size
MP04-265-18	18 cm (7")



Adson Haemostatic Forcep
Straight

Catalog #	Size
MP04-268-18	19 cm (7 1/2")



Adson Haemostatic Forcep
Curved

Catalog #	Size
MP04-269-18	18.5 cm (7 1/4")



Adson Haemostatic Forcep
Curved

Catalog #	Size
MP04-271-21	21.5 cm (8 1/2")



Jacobson Haemostatic Forcep
Curved

Catalog #	Size
MP04-275-19	19 cm (7 1/2")



Dunhill Haemostatic Forcep
Gently Curved

Catalog #	Size
MP04-277-19	19 cm (7 1/2")



Grey-Turner Haemostatic Forcep
Curved

Catalog #	Size
MP04-279-19	18 cm (7")



Dandy-Mosquito Haemostatic Forcep
Laterally Curved, Cross Serrated

Catalog #	Size
MP04-281-12	12 cm (4 3/4")



Dandy Haemostatic Forcep
Laterally Curved

Catalog #	Size
MP04-283-14	14.5 cm (5 3/4")



Dandy Haemostatic Forcep
Laterally Curved, 1 x 2 Teeth

Catalog #	Size
MP04-285-14	14.5 cm (5 3/4")



Cairns Haemostatic Forcep
Straight

Catalog #	Size
MP04-290-15	15 cm (6")



Cairns Haemostatic Forcep
Curved

Catalog #	Size
MP04-291-15	15 cm (6")



Cairns Haemostatic Forcep
Curved to Side

Catalog #	Size
MP04-293-14	14.5 cm (5 3/4")



Dunhill Haemostatic Forcep
Straight

Catalog #	Size
MP04-295-13	13 cm (5")



Lovlace Haemostatic Forcep
Straight, Cross Serrated

Catalog #	Size
MP04-300-16	16 cm (6 1/4")



Lovlace Haemostatic Forcep
Straight, Cross Serrated, 1 x 2 Teeth

Catalog #	Size
MP04-302-16	16 cm (6 1/4")





Martin-Fuchsig Haemostatic Forcep
Curved

Catalog #	Size
MP04-305-20	20.5 cm (8")



Nissen Haemostatic Forcep
Curved

Catalog #	Size
MP04-307-18	18.5 cm (7 1/4")



Schnidt Tonsil Haemostatic Forcep
Strongly Curved

Catalog #	Size
MP04-311-01	18.5 cm (7 1/4")



Schnidt Tonsil Haemostatic Forcep
Gently Curved

Catalog #	Size
MP04-311-02	19 cm (7 1/2")



Negus Haemostatic Forcep
Fig. 1

Catalog #	Size
MP04-315-01	19.5 cm (7 ¾")



Negus Haemostatic Forcep
Fig. 2

Catalog #	Size
MP04-315-02	20 cm (8")



Wilson Haemostatic Forcep
Curved

Catalog #	Size
MP04-317-19	19 cm (7 ½")



**Rochester-Carmalt Haemostatic Forcep
Straight**

Catalog #	Size
MP04-320-16	17 cm (6 ¾")
MP04-320-20	20.5 cm (8")



**Rochester-Carmalt Haemostatic Forcep
Curved**

Catalog #	Size
MP04-321-16	16.5 cm (6 ½")
MP04-321-20	20 cm (8")



Fickling Haemostatic Forcep

Catalog #	Size
MP04-331-18	18 cm (7")



Fickling Haemostatic Forcep
1 x 2 Teeth

Catalog #	Size
MP04-333-18	18 cm (7")



Bainbridge Haemostatic Forcep
Straight, Longitudinally Serrated

Catalog #	Size
MP04-340-15	15 cm (6")
MP04-340-18	18.5 cm (7 1/4")



Bainbridge Haemostatic Forcep
Curved, Longitudinally Serrated

Catalog #	Size
MP04-341-15	15 cm (6")
MP04-341-18	18.5 cm (7 1/4")



Birkett Haemostatic Forcep
Straight

Catalog #	Size
MP04-346-18	18.5 cm (7 1/4")



Birkett Haemostatic Forcep
Curved

Catalog #	Size
MP04-347-18	18.5 cm (7 1/4")



Bengolea Haemostatic Forcep
Straight

Catalog #	Size
MP04-350-20	21.5 cm (8 1/2")
MP04-350-26	26 cm (10 1/4")



Bengolea Haemostatic Forcep
Curved

Catalog #	Size
MP04-351-20	21 cm (8 1/4")
MP04-351-26	25.5 cm (10")

Bengolea Haemostatic Forcep
Straight, 1 x 2 Teeth

Catalog #	Size
MP04-352-20	21.5 cm (8 1/2")
MP04-352-26	26 cm (10 1/4")



Bengolea Haemostatic Forcep
Curved, 1 x 2 Teeth

Catalog #	Size
MP04-353-20	21 cm (8 1/4")
MP04-353-26	25.5 cm (10")



Roberts Haemostatic Forcep
Straight

Catalog # Size
MP04-360-22 22.5 cm (8 ¾")



Roberts Haemostatic Forcep
Curved

Catalog # Size
MP04-361-22 21.5 cm (8 ½")



Sarot Haemostatic Forcep
Straight

Catalog # Size
MP04-364-24 25 cm (9 ¾")



Sarot Haemostatic Forcep
Curved

Catalog # Size
MP04-365-24 24.5 cm (9 ¾")





Crafoord Haemostatic Forcep
Curved

Catalog #	Size
MP04-371-18	18 cm (9 3/4")
MP04-371-24	24.5 cm (9 3/4")



Crafoord- Sellors Haemostatic Forcep

Catalog #	Size, Profile
MP04-375-01	24 cm (9 1/2"), Fig. 1
MP04-375-02	24 cm (9 1/2"), Fig. 2
MP04-375-03	24 cm (9 1/2"), Fig. 3



Bridge Haemostatic Forcep
Straight

Catalog #	Size
MP04-380-27	27.5 cm (10 3/4")



Bridge Haemostatic Forcep
Curved

Catalog #	Size
MP04-381-27	27.5 cm (10 3/4")

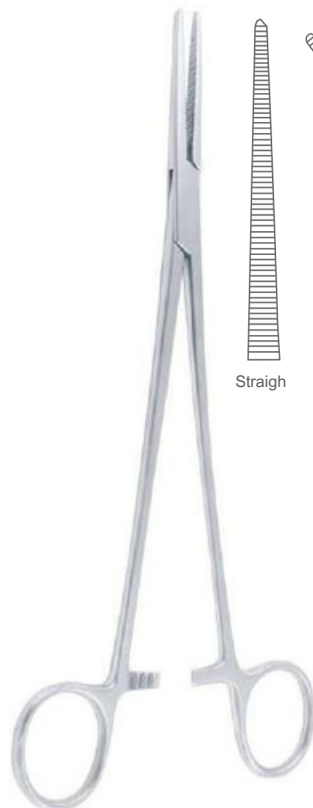

Heiss Haemostatic Forcep

Catalog #	Size, Profile
MP04-386-20	21 cm (8 1/4"), Straight
MP04-387-20	20.5 cm (8"), Gently Curved
MP04-389-20	20 cm (8"), Strongly Curved

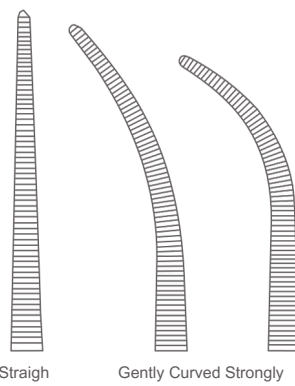



Heiss Haemostatic Forcep
Straight, 1 x 2 Teeth

Catalog #	Size
MP04-390-20	20 cm (8")



Heiss Haemostatic Forcep
Curved, 1 x 2 Teeth

Catalog #	Size
MP04-391-20	20 cm (8")



Overholt-Martin Dissecting and Ligature Forcep

Catalog #	Size
MP04-401-01	18.5 cm (7 1/4"), Fig. 1
MP04-401-02	20.5 cm (8"), Fig. 2
MP04-401-03	21 cm (8 1/4"), Fig. 3
MP04-401-04	21.5 cm (8 1/2"), Fig. 4
MP04-401-05	24.5 cm (9 3/4"), Fig. 5

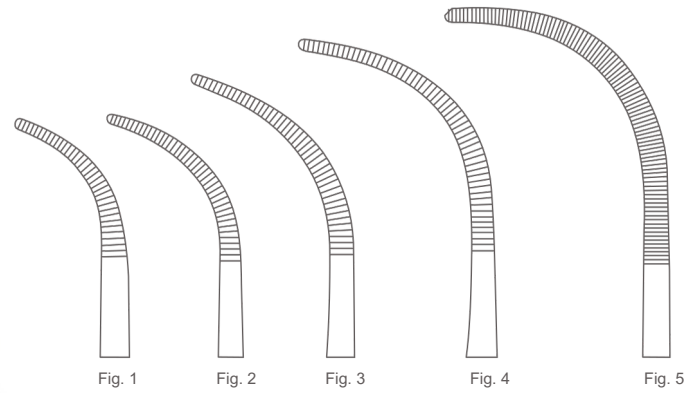



Dissecting and Ligature Forcep
Smooth Jaws

Catalog #	Size
MP04-404-12	12.5 cm (5")



Adson-Baby Dissecting and Ligature Forcep
Curved

Catalog #	Size
MP04-411-14	14.5 cm (5 3/4")
MP04-411-18	18 cm (7")



Overholt-Baby Dissecting and Ligature Forcep
Curved

Catalog #	Size
MP04-415-14	14 cm (5 ½")



Overholt-Mixter Dissecting and Ligature Forcep
Curved

Catalog #	Size
MP04-417-21	21.5 cm (8 ½")



Overholt-Geissendoerfer Dissecting and Ligature Forcep

Catalog #	Size
MP04-421-01	20.5 cm (8"), Fig. 1
MP04-421-02	21.5 cm (8 1/2"), Fig. 2
MP04-421-03	22 cm (8 3/4"), Fig. 3
MP04-421-04	21.5 cm (8 1/2"), Fig. 4
MP04-421-05	22 cm (8 3/4"), Fig. 5
MP04-421-06	22 cm (8 3/4"), Fig. 6
MP04-421-07	22 cm (8 3/4"), Fig. 7

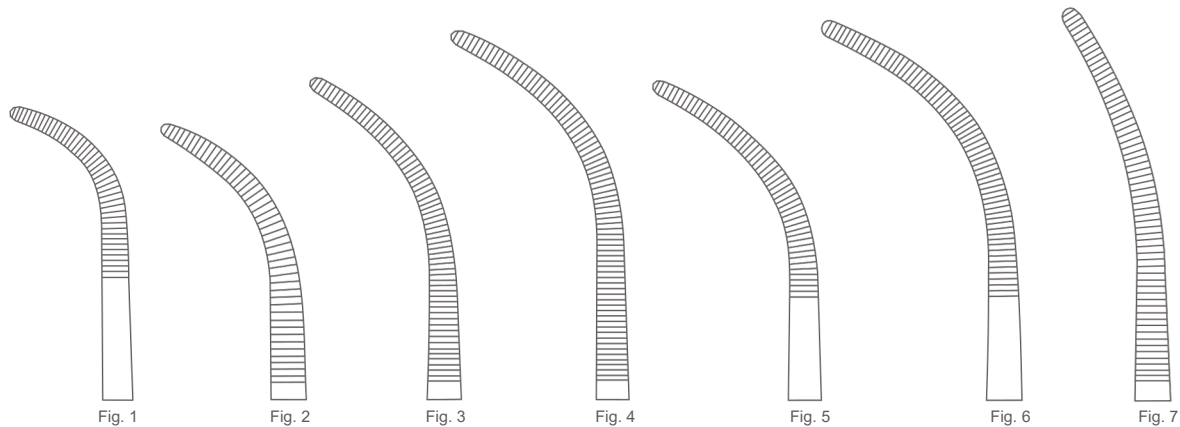



Overholt-Geissendoerfer Dissecting and Ligature Forcep

Catalog #	Size
MP04-423-01	27 cm (10 3/4"), Fig. 1 26.5 cm (10 1/2")
MP04-423-02	Fig. 2 27.5 cm (10 3/4")
MP04-423-03	Fig. 3 28 cm (11"), Fig. 4 27.5 cm (10 3/4")
MP04-423-04	Fig. 5 28 cm (11"), Fig. 6 27.5 cm (10 3/4")
MP04-423-05	Fig. 7

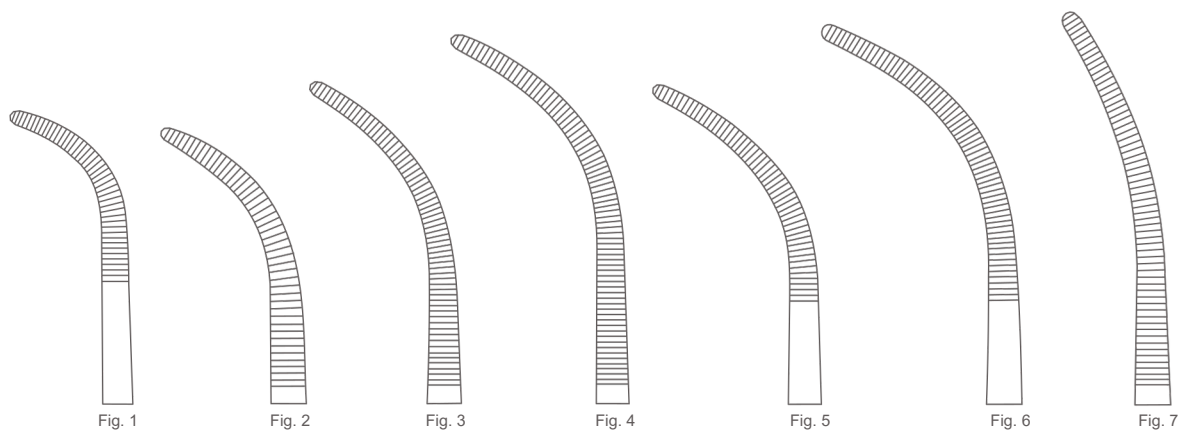



Overholt-Fine Dissecting and Ligature Forcep

Curved

Catalog #	Size
MP04-427-00	21.5 cm (8 1/2")
MP04-427-01	21 cm (8 1/4")
MP04-427-02	22 cm (8 3/4")
MP04-427-03	23 cm (9")
MP04-427-06	22.5 cm (8 3/4")

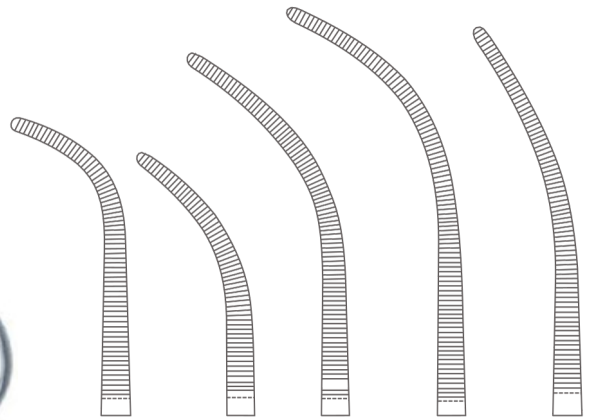

Overholt Dissecting and Ligature Forcep

Curved

Catalog #	Size
MP04-429-00	29.5 cm (11 1/2")
MP04-429-01	29.5 cm (11 1/2")
MP04-429-06	30 cm (11 3/4")

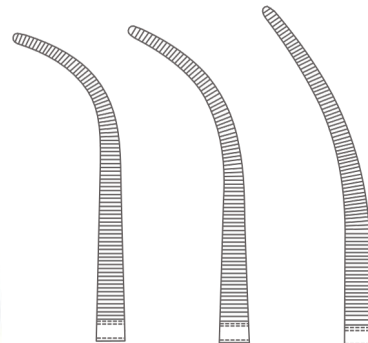

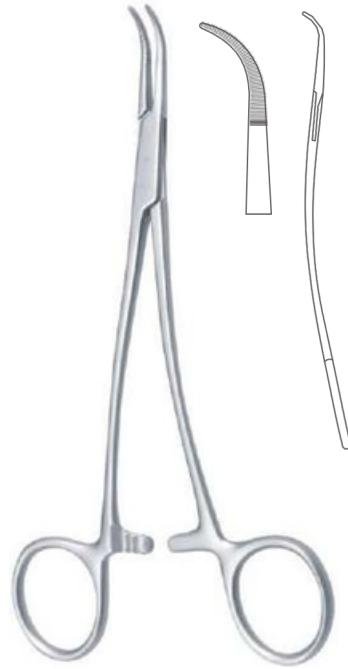

Overholt-Mini Dissecting and Ligature Forcep
Curve, S Shaped

Catalog #	Size
MP04-431-15	15 cm (6")



Overholt-Mini Dissecting and Ligature Forcep
Curve

Catalog #	Size
MP04-433-20	20 cm (8")



Kelly Dissecting and Ligature Forcep Fig. 1

Catalog #

MP04-441-19

MP04-441-22

MP04-441-24

Size

19.5 cm (7 3/4")

22.5 cm (8 3/4")

24.5 cm (9 3/4")



Kelly Dissecting and Ligature Forcep Fig. 2

Fig. 2

Catalog #

MP04-443-19

MP04-443-22

MP04-443-24

Size

19 cm (7 1/2")

22 cm (8 3/4")

24 cm (9 1/2")



Kelly Dissecting and Ligature Forcep Fig. 3

Catalog #

MP04-445-19

Size

18.5 cm (7 1/4")

MP04-445-22

21.5 cm (8 1/2")

MP04-445-24

23.5 cm (9 1/4")



Lawrence Dissecting and Ligature Forcep Curved

Catalog #

MP04-451-28

Size

28 cm (11")



Meeker Dissecting and Ligature Forcep Right Angled

Catalog #

MP04-455-28

Size

28 cm (11")



Mini-Gemini Dissecting and Ligature Forcep

Curved

Catalog #	Size
MP04-469-18	18 cm (7")
MP04-469-22	22.5cm (8 3/4")
MP04-469-25	25 cm (9 3/4")
MP04-469-28	28.5 cm (11 1/4")



Gemini Dissecting and Ligature Forcep

Curved

Catalog #	Size
MP04-471-13	13 cm (5")
MP04-471-16	16 cm (6 1/4")
MP04-471-18	18 cm (7")
MP04-471-20	21 cm (8 1/4")
MP04-471-23	23 cm (9")
MP04-471-25	25 cm (9 3/4")
MP04-471-28	28 cm (11")



Rumel Dissecting and Ligature Forcep Curved

Catalog #	Size
MP04-475-01	24 cm (9 1/2")
MP04-475-02	23.5 cm (9 1/2")
MP04-475-03	23 cm (9")
MP04-475-04	24 cm (9 1/2")
MP04-475-05	23.5 cm (9 1/4")



Zenker Dissecting and Ligature Forcep Curved

Catalog #	Size
MP04-479-01	29.5 cm (11 1/2")
MP04-479-02	28.5 cm (11 1/4")





Kieback Dissecting and Ligature Forcep
Curved

Catalog #	Size
MP04-481-23	23.5 cm (9 ¼")



Mixer-Baby Dissecting and Ligature Forcep
Gently Curved

Catalog #	Size
MP04-491-01	13.5 cm (5 ¼")



Mixer-Baby Dissecting and Ligature Forcep
Strongly Curved

Catalog #	Size
MP04-491-02	13 cm (5")



Mixer-Baby Dissecting and Ligature Forcep
Curved

Catalog #	Size
MP04-493-14	13.5 cm (5 ¼")



Mixer-Baby Dissecting and Ligature Forcep

Curved

Catalog #	Size
MP04-495-18	18.5 cm (7 1/4")



Mixer Dissecting and Ligature Forcep

Right Angled

Catalog #	Size
MP04-497-15	16 cm (6 1/4")
MP04-497-19	18 cm (7")

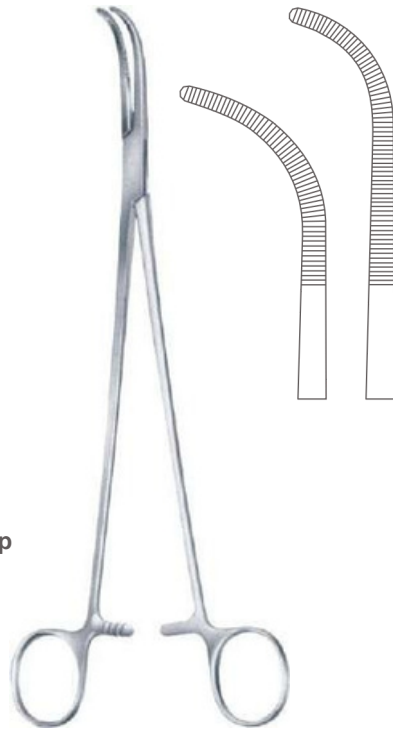

Mixer Dissecting and Ligature Forcep

Curved

Catalog #	Size
MP04-499-22	22.5 cm (8 ¾")
MP04-499-23	23 cm (9")



Mixer Dissecting and Ligature Forcep

Right Angled, Longitudinally Serrated

Catalog #	Size
MP04-501-22	22.5 cm (8 ¾")
MP04-501-25	26 cm (10 ¼")
MP04-501-28	28 cm (11")



McQuigg-Mixer Dissecting and Ligature Forcep

Right Angled, Longitudinally Serrated

Catalog #	Size
MP04-505-22	23.5 cm (9 1/4")



Mixer-O'Shaughnessy Dissecting and Ligature Forcep

Curved

Catalog #	Size
MP04-509-19	18.5 cm (7")



O'Shaughnessy Dissecting and Ligature Forcep

Curved

Catalog #	Size
MP04-511-14	15 cm (6")
MP04-511-17	18 cm (7")
MP04-511-20	20 cm (8")
MP04-511-23	23 cm (9")
MP04-511-26	26 cm (10 1/4")



Wickstroem Dissecting and Ligature Forcep

Right Angled

Catalog #	Size
MP04-517-21	21 cm (8 1/4")
MP04-517-24	24.5 cm (9 3/4")



Lahey Dissecting and Ligature Forcep

Curved

Catalog #	Size
MP04-519-18	18.5 cm (7 1/4")





Kantrowitz Dissecting and Ligature Forcep
Right Angled

Catalog #	Size
MP04-523-20	20 cm (8")
MP04-523-25	25 cm (9 3/4")
MP04-523-27	27.5 cm (10 3/4")



Barre Dissecting and Ligature Forcep
Extra Delicate

Catalog #	Size
MP04-527-28	28 cm (11")



Barre Dissecting and Ligature Forcep
Delicate

Catalog #	Size
MP04-529-28	28 cm (11")



Lahey (Sweet) Bile Duct Clamp
Curved

Catalog #	Size
MP04-535-19	19.5 cm (7 3/4")



Lahey Bile Duct Clamp
Angled

Catalog #	Size
MP04-537-23	22.5 cm (8 ¾")



Lahey (Sweet) Bile Duct Clamp
Curved

Catalog #	Size
MP04-539-23	23 cm (9")



Finochietto Dissecting and Ligature Forcep
Right Angled

Catalog #	Size
MP04-541-24	24 cm (9 ½")

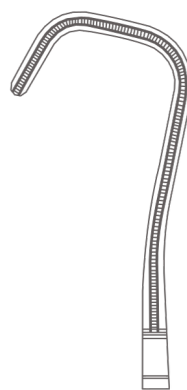

Fig. 1

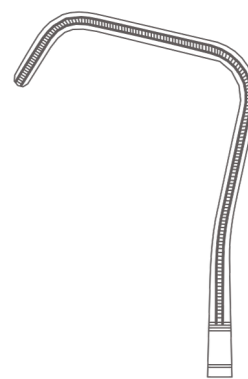
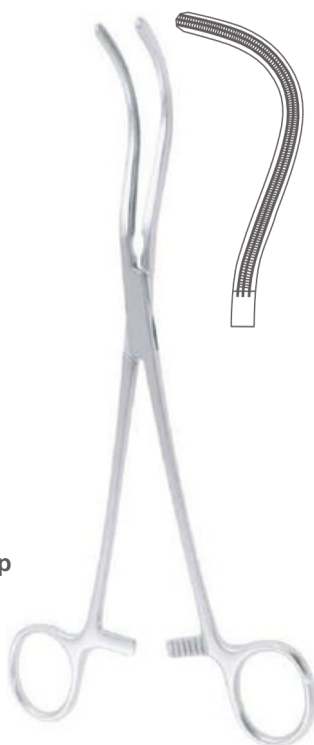

Fig. 2

Uro-Tangential Atrauma Tangential Forcep

Catalog #	Size, Profile
MP04-551-01	25 cm (9 ¾"), Fig. 1
MP04-551-02	27 cm (10 ¾"), Fig. 2



Guyon Atrauma Kidney Pedicle Clamp Curved

Catalog #	Size
MP04-561-23	23 cm (9")
MP04-561-24	24 cm (9 ½")

Guyon Kidney Pedicle Clamp Curved

Catalog #	Size
MP04-563-23	24 cm (9 ½")





Guyon Kidney Pedicle Clamp
Curved

Catalog #	Size
MP04-565-20	19.5 cm (7 ¾")
MP04-565-22	21.5 cm (8 ½")
MP04-565-24	24 cm (9 ½")



Stille Kidney Pedicle Clamp
Curved, Grooved

Catalog #	Size
MP04-569-23	23 cm (9")



Herrick Kidney Pedicle Clamp
Double Angled, Longitudinally Serrated

Catalog #	Size
MP04-571-23	23 cm (9")



Desjardins Bile Duct Clamp
Curved Downwards

Catalog #	Size
MP04-581-21	21 cm (8 ¼")



Nissen Bile Duct Clamp
Curved Downwards

Catalog #	Size
MP04-583-21	21.5 cm (8 1/2")

Gray Dissecting and Ligature Forcep
Curved S Shaped

Catalog #	Size
MP04-591-01	22 cm (8 3/4")
MP04-591-02	22 cm (8 3/4")



Phaneuf Hysterectomy Forcep
Straight, 1 x 2 Teeth

Catalog #	Size
MP04-594-21	20.5 cm (8")

Phaneuf Hysterectomy Forcep
Curved, 1 x 2 Teeth

Catalog #	Size
MP04-595-21	20 cm (8")





Maingot Hysterectomy Forcep
Curved, 1 x 2 Teeth

Catalog #	Size
MP04-597-20	20.5 cm (8")
MP04-597-25	25 cm (9 3/4")



Maingot Hysterectomy Forcep
Straight, 1 x 2 Teeth

Catalog #	Size
MP04-598-20	20 cm (8")



Heaney-Ballentine Hysterectomy Forcep
Straight

Catalog #	Size
MP04-600-21	21.5 cm (8 1/2")



Heaney-Ballentine Hysterectomy Forcep
Curved

Catalog #	Size
MP04-601-21	21.5 cm (8 1/2")

Heaney-Razek Hysterectomy Forcep
Straight

Catalog #	Size
MP04-604-21	21 cm (8 ¼")

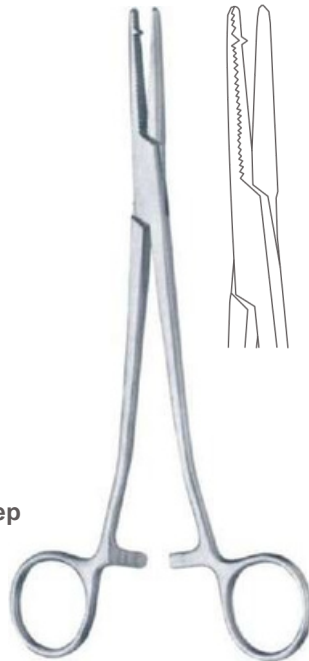

Heaney Hysterectomy Forcep
Curved, 1 Tooth

Catalog #	Size
MP04-607-19	19.5 cm (7 ¾")
MP04-607-21	21.5 cm (8 ½")
MP04-607-23	24 cm (9 ½")



Heaney Hysterectomy Forcep
Curved, 2 Tooth

Catalog #	Size
MP04-609-19	19.5 cm (7 ¾")
MP04-609-21	21.5 cm (8 ½")
MP04-609-23	24 cm (9 ½")



Dick Atrauma Vaginal Clamp
Angled

Catalog #	Size
MP04-621-25	25.5 cm (10")
MP04-621-26	26.5 cm (10 ½")
MP04-621-27	27.5 cm (10 ¾")





Wertheim Atrauma Vaginal Clamp

Right Angled

Catalog #	Size
MP04-625-25	25 cm (9 3/4")



Wertheim-Cullen Vaginal Clamp

Catalog #	Size
MP04-629-21	21 cm (8 1/4")



Heaney (Rogers) Hysterectomy Forcep

Catalog #	Size
MP04-635-10	21.5 cm (8 1/2"), Fig. 1
MP04-635-20	21 cm (8 1/4"), Fig. 2
MP04-635-30	20.5 cm (8"), Fig. 3
MP04-635-40	20 cm (8"), Fig. 4



Fig. 1

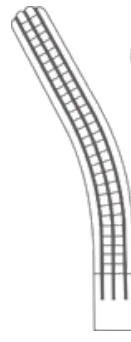

Fig. 2

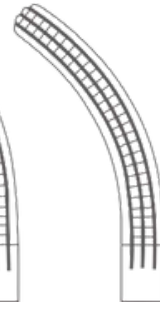

Fig. 3

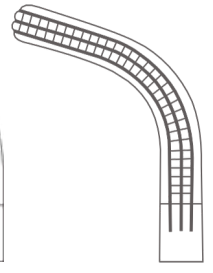

Fig. 4

Wertheim (Rogers) Hysterectomy Forcep

Catalog #	Size
MP04-637-10	25.5 cm (10"), Fig. 1
MP04-637-20	25 cm (9 3/4"), Fig. 2
MP04-637-30	24.5 cm (9 3/4"), Fig. 3



Fig. 1

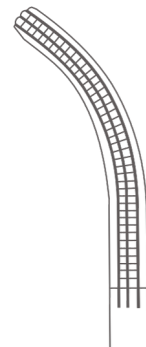

Fig. 2



Fig. 3



Wertheim Hysterectomy Forcep
Angled

Catalog # Size
MP04-639-22 22 cm (8 3/4")

Segond-Landau Hysterectomy Forcep
Straight

Catalog # Size
MP04-642-24 24 cm (9 1/2")



Segond Hysterectomy Forcep
Curved

Catalog # Size
MP04-643-24 24 cm (9 1/2")

Holzbach Hysterectomy Forcep
Straight

Catalog # Size
MP04-646-24 24.5 cm (9 3/4")





Holzbach Hysterectomy Forcep
Curved

Catalog #	Size
MP04-647-24	24.5 cm (9 3/4")

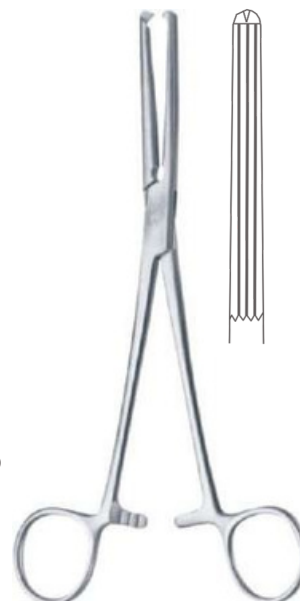

Gwilliam Hysterectomy Forcep
Straight

Catalog #	Size
MP04-648-20	20 cm (8")



Gwilliam Hysterectomy Forcep
Curved

Catalog #	Size
MP04-649-20	20 cm (8")

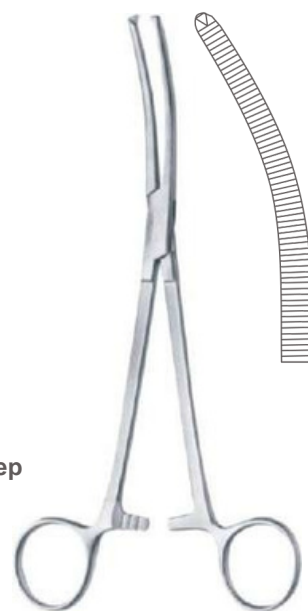

Berkeley-Bonney Hysterectomy Forcep
Curved

Catalog #	Size
MP04-651-20	20 cm (8")



Kieback Hysterectomy Forcep
Straight

Catalog #	Size
MP04-654-25	25 cm (9 3/4")



Kieback Hysterectomy Forcep
Curved

Catalog #	Size
MP04-655-25	25 cm (9 3/4")



Burke Hysterectomy Forcep
Curved, Short Jaws

Catalog #	Size
MP04-657-25	25 cm (9 3/4")



Burke Hysterectomy Forcep
Curved, Long Jaws

Catalog #	Size
MP04-659-25	25 cm (9 3/4")



Moynihan Hysterectomy Forcep
Curved

Catalog #	Size
MP04-661-23	23 cm (9")



Moynihan Hysterectomy Forcep
Curved

Catalog #	Size
MP04-663-24	23.5 cm (9 1/4")



Wertheim Hysterectomy Forcep
Curved

Catalog #	Size
MP04-667-25	26 cm (10 1/4")



Wertheim Hysterectomy Forcep
Curved , 1 x 2 Teeth

Catalog #	Size
MP04-669-22	22.5 cm (8 3/4")



Wertheim Hysterectomy Forcep

Curved , 1 x 2 Teeth

Catalog #	Size
MP04-671-23	22.5 cm (8 ¾")

Fergusson Angiotribe
Straight

Catalog #	Size
MP04-680-16	16 cm (6 ¼")
MP04-680-20	20 cm (8")

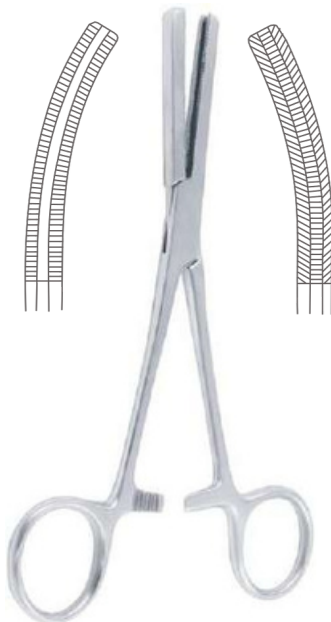

Fergusson Angiotribe
Curved

Catalog #	Size
MP04-681-16	16 cm (6 ¼")
MP04-681-20	20 cm (8")

Mikulicz-Baby Peritoneum Forcep
Curved, 1 x 2 Teeth

Catalog #	Size
MP04-685-14	14 cm (5 ¾")





Mikulicz Peritoneum Forcep
Curved, 1 x 2 Teeth

Catalog #	Size
MP04-687-18	18.5 cm (7 1/4")



Mikulicz Peritoneum Forcep
Curved, 1 x 2 Teeth

Catalog #	Size
MP04-689-20	20 cm (8")

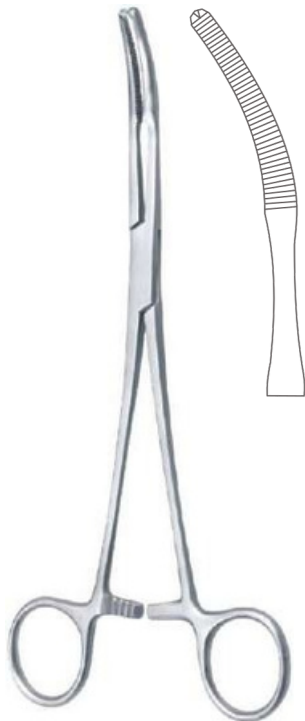

Mikulicz Peritoneum Forcep
Curved, 1 x 2 Teeth

Catalog #	Size
MP04-691-20	20 cm (8")



Mikulicz Peritoneum Forcep
Curved, Longitudinal Serrations, 1 x 2 Teeth

Catalog #	Size
MP04-693-24	24.5 cm (9 3/4")



Mikulicz Peritoneum Forcep
Curved, 1 x 2 Teeth

Catalog #	Size
MP04-695-21	20.5 cm (8")



Faure Peritoneum Forcep
Curved, 1 x 2 Teeth

Catalog #	Size
MP04-697-20	21 cm (8 ¼")



Faure Peritoneum Forcep
Curved, 1 x 2 Teeth

Catalog #	Size
MP04-699-20	21 cm (8 ¼")

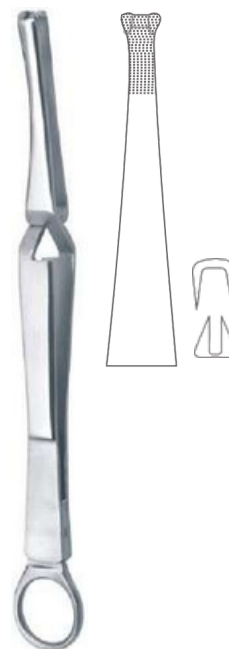

Doyen Towel Clamp

Catalog #	Size
MP04-751-18	18 cm (7")



Schaedel Towel Clamp
Sharp

Catalog #	Size
MP04-755-09	9 cm (3 1/2")



Jones Towel Clamp
Sharp

Catalog #	Size
MP04-761-05	5.5 cm (2 1/2")
MP04-761-09	8.5 cm (3 1/4")



Martin-Jones Towel Clamp
Sharp, With Cable Holder

Catalog #	Size
MP04-765-	8.5 cm (3 1/4")

Robin Towel Clamp

Catalog #	Size, Usage
MP04-769-01	13.5 cm (5 1/4"), For Cable Up To 5 mm
MP04-769-02	13.5 cm (5 1/4"), For Cable Up To 13 mm



Backhaus Towel Clamp
With Tube Holder

Catalog #	Size
MP04-771-11	13 cm (5")



Backhaus Towel Clamp

Catalog #	Size
MP04-773-08	9 cm (3 1/2")
MP04-773-11	11.5 cm (4 1/2")
MP04-773-13	13 cm (5")
MP04-773-15	16 cm (6 1/4")



Roeder Towel Clamp

Catalog #	Size
MP04-777-13	13.5 cm (5 1/4")



Lorna Towel Clamp
Fine Serrated, Wide Jaw

Catalog #	Size
MP04-781-10	9.5 cm (3 3/4")
MP04-781-13	13 cm (5")





Bernhard Towel Clamp

Catalog #	Size
MP04-785-16	16.5 cm (6 ½")



Tohoku Towel Clamp
Blunt

Catalog #	Size
MP04-787-10	10.5 cm (4")
MP04-787-13	13.5 cm (5 ¼")



Non Perforating Towel Clamp

Catalog #	Size
MP04-791-10	10 cm (4")
MP04-791-13	13.5 cm (5 ¼")



Peers-Bretram Towel Clamp
With Jaw for Tube Fixation

Catalog #	Size
MP04-793-14	14.5 cm (5 ¾")

Towel Clamp For Paper Clothes

Catalog #	Size
MP04-795-11	11.5 cm (4 1/2")
MP04-795-14	14 cm (5 1/2")



Lane Towel Clamp

Catalog #	Size
MP04-799-13	13 cm (5")
MP04-799-15	15.5 cm (6")
MP04-799-20	19.5 cm (7 3/4")



Klinikum Berlin Tubing Clamp Extra Long Ratchet

Catalog #	Size
MP04-850-14	14 cm (5 1/2")



Presbyterian Tubing Clamp

Catalog #	Size
MP04-852-16	16.5 cm (6 1/2")
MP04-852-18	18 cm (7")



Tubing Clamp

Catalog #	Size
MP04-860-15	15.5 cm (6")
MP04-860-18	19 cm (7 1/2")
MP04-860-20	20.5 cm (8")



Tubing Clamp With Safety Guard

Catalog #	Size
MP04-862-15	15.5 cm (6")
MP04-862-18	19 cm (7 1/2")
MP04-862-20	20.5 cm (8")



Brompton Tube Milking Roller

Catalog #	Size
MP04-890-00	Standard



Hoffmann Tubing Clamp

Catalog #	Width
MP04-950-13	13 mm
MP04-950-17	17 mm
MP04-950-20	20 mm
MP04-950-25	25 mm
MP04-950-30	30 mm
MP04-950-40	40 mm



Mohr Pinchcocks

Catalog #	Width
MP04-953-40	40 mm
MP04-953-50	50 mm
MP04-953-60	60 mm
MP04-953-70	70 mm
MP04-953-80	80 mm

